



POGA REFERENCE GUIDE

EFFECTIVE AUGUST 2013



Table of Contents

General POGA Information	1
Sizing Charts.....	8
Accessory Bag Dimensions.....	10
Kit Installation Times.....	11
Covers	12-13
Touring Bags	14-18
Touring Accessories	19-23
Windscreens.....	24-25
Custom Accessories	26-35
Mountain Accessories	36-43
Utility	44-48
Tracks	49-50
Wearbars	51-52
Traction & Control	53-58
General Maintenance	59-61
Oil & Care	62-65
Misc Accessories	66-68
120	71
Upgrade Kits	71
Helmet and Neck Brace Parts	72-79
High Altitude Kits.....	80
2014 Optional Rear Suspension Springs.....	80
Drive Belt Application Guide	81
Drive Belt Dimension Chart.....	82
Index	84

Sizing Charts

Adult Helmets*

Helmet Size	Head-Hat Size	Head Circumference (in.)	Head Circumference (cm)
2XS	6 1/2-6 5/8	20 1/2-20 7/8	52-53
XS	6 3/4-6 7/8	21 1/4-21 5/8	54-55
Small	7-7 1/8	22-22 1/2	56-57
Medium	7 1/4-7 3/8	22 3/4-23 1/4	58-59
Large	7 1/2-7 5/8	23 5/8-24	60-61
XL	7 3/4-7 7/8	24 1/2-24 7/8	62-63
2XL	8-8 1/4	25 1/8-25 1/2	64-65
3XL	8 3/8-8 1/2	26-26 3/8	66-67
4XL	8 1/2-8 5/8	26 3/4-27 1/8	68-69

■NOTE: MX SnoCross helmets run about one size smaller on average than the regular shield helmets (i.e. MX SnoCross Large = Shield Helmet Medium).

Youth Helmets

Helmet Size	Head-Hat Size	Head Circumference (in.)	Head Circumference (cm)
Medium	6 1/8 - 6 1/4	19 - 20	48 - 49
Large	6 3/8 - 6 1/2	20 - 21 1/2	50 - 51

■NOTE: This is a guideline only. Head shape can vary size.

■NOTE: Sizing charts should be used as general guides for determining approximate size. Differences in individual body shape, as well as the type of cut and style of each garment, should be considered to ensure appropriate fit. Please visit your local Authorized Arcticwear Dealer to try on your selection.

Men's Outerwear

Size	Chest	Waist	Inseam
S	36" - 38"	28" - 30"	31"
M	40" - 42"	32" - 34"	31"
MT	40" - 42"	32" - 34"	34"
L	44" - 46"	36" - 40"	32"
LT	44" - 46"	36" - 40"	35"
XL	48" - 50"	42" - 44"	33"
XLT	48" - 50"	42" - 44"	36"
2XL	52" - 54"	46" - 48"	33"
2XLT	52" - 54"	46" - 48"	36"
3XL	56" - 58"	50" - 52"	33"
3XLT	56" - 58"	50" - 52"	36"
4XL	60" - 62"	54" - 56"	33"
5XL	64" - 66"	58" - 60"	33"

■NOTE: 5' 11" and taller, use tall sizes.

Women's Outerwear

Size	Chest	Waist	Hips	Inseam
XS	26" - 30"	19" - 23"	30" - 34"	31"
S	30" - 34"	23" - 26"	34" - 37"	31"
M	34" - 37"	26" - 30"	37" - 40"	31"
MT	34" - 37"	26" - 30"	37" - 40"	33"
L	37" - 40"	30" - 34"	40" - 43"	31"
LT	37" - 40"	30" - 34"	40" - 43"	33"
XL	40" - 43"	34" - 38"	43" - 46"	31"
XLT	40" - 43"	34" - 38"	43" - 46"	33"
2XL	43" - 46"	38" - 41"	46" - 49"	31"
3XL	46" - 49"	41" - 45"	49" - 52"	31"
4XL	49" - 52"	45" - 49"	52" - 55"	31"

■NOTE: 5' 8" and taller, use tall sizes.

Youth Outerwear

Size	Height	Chest	Waist	Inseam
4	45" - 47"	23" - 25"	20" - 22"	17"
6	47" - 49"	25" - 26"	22" - 23"	19"
8	49" - 50"	26" - 27"	23" - 24"	21"
10	51" - 54"	27" - 28"	24" - 25"	23"
12	55" - 58"	29" - 30"	25" - 26"	25"
14	59" - 61"	30" - 32"	26" - 27"	26"
16	62" - 64"	32" - 33"	27" - 28"	27"

One-Piece

Size	Height	Chest	Waist	Inseam
2	33" - 35"	21" - 22"	19" - 20"	16"
3	36" - 38"	22" - 23"	20" - 21"	17"
4	39" - 41"	23" - 24"	21"	18"
5	42" - 44"	24" - 25"	21" - 22"	19"
6	45" - 46"	25" - 26"	22"	20"
7	47" - 49"	26" - 27"	22" - 23"	21"

Glossary

Missy/Womens - Missy sizes, also referred to as straight sizes, are the sizes most commonly carried in standard women's clothing stores and generally run from 2 to 18 in even sizes.

Juniors - Juniors sizes are designed for young women ages 13 to 18 and are usually cut slimmer in the hips and bust than missy sizes. They're designated by uneven sizes 0 to 17.

Accessory Bag Dimensions

Ref	p/n	Description		Length	Width/Depth	Height
106	6639-050	Saddlebags		18"	6"	10"
106	6639-201	2-Up Saddlebags		20"	5"	10"
106	6639-046	Seat Pocket		7"	7"	3"
106	6639-047	Seat Pack		14"	14"	9"
106	4639-712	Touring Saddlebags		22"	7"	12"
107	5606-171	Touring Gear Bag		19"	13"	9"
107	6639-276	Tunnel Gear Bag		22"	12"	7"
107	5639-574	Tunnel Gear Bag		20"	12"	8"
107	6639-183	Tunnel Pack		15"	12"	4"
107	5639-573	Tunnel Pack		13"	13"	7"
107	5639-433	Tunnel Pack		24"	15"	6"
108	6639-277	Tunnel Cargo Bag	Main Side	20" 21"	12" 5"	5" 10"
108	6639-112	Crosstour Rack Bag		11"	15"	10"
108	5639-767	Goggle Holder		9"	6"	4"
108	6639-097	Hood Packs		8"	5"	5"
108	6639-200	Tank Bag		18"	7"	12"
109	5639-712	Windshield Bag		9"	14"	4"
109	6639-278	Windshield Bag		9"	14"	4"
109	6639-051	Windshield Bag		10"	25"	6"
109	6639-279	Windshield Bag		10"	25"	6"
109	4639-714	Windshield Bag		23"	10"	6"
109	5639-304	Windshield Bag		24"	12"	6"
109	4639-428	Windshield Bag		26"	3"	5"
109	6639-468	Handlebar Bag		7"	10"	5"
109	6639-469	Handlebar Bag		7"	10"	8"
109	5639-434	Handlebar Bag		6"	7"	7"
109	5639-041	Custom Handlebar Bag		8"	4"	6"
131	6639-401	Mountain Pack		9"	14"	6"
131	6639-402	Mountain Gear Bag		18"	14"	8"
132	4639-732	Goggle Holder		10"	3"	6"
140	5639-049	Bearcat Gear Bag		31"	17"	15"
140	6606-252	Tunnel Pack		14"	17"	10"
17	4639-426	Tank Bag		13"	9"	10"
18	3639-715	Windshield Bag		38"	5"	7"
18	3639-962	Windshield Bag		13"	3"	7"
19	4639-427	Windshield Flair Bags		4"	11"	3"
19	3639-722	Firecat Trunk Bag		10"	14"	7"
19	5639-305	Underhood Bag		9"	21"	9"
37	6639-574	Tunnel Pack		16"	12"	4"
38	5639-044	Mountain Gear Bag		14"	20"	9"
38	4639-727	Mountain Gear Bag	Main Side	17" 10"	16" 4"	8" 7"
38	5639-043	Mountain Seat Bag		12"	16"	9"

Covers

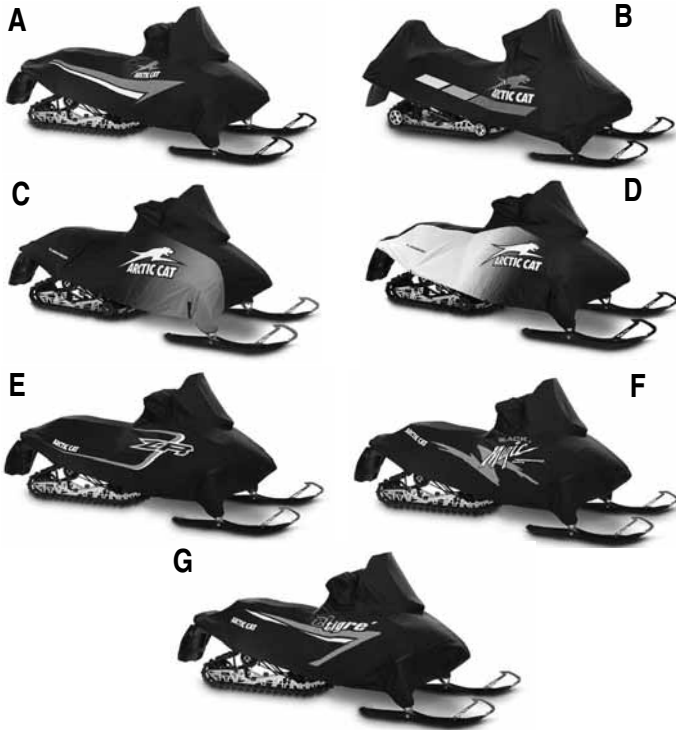

Page 102

PREMIUM COVERS

Trailerable

Application	p/n
(A) '14 ZR, ZR LXR, ZR SP; '12-'13 F 800, 1100, 1100T - Green	6639-218
(A) '14 ZR, ZR LXR, ZR SP; '12-'13 F 800, 1100, 1100T - Orange	6639-219
(A) '14 XF, XF CC, XF CT; '12-'13 XF; '13 XF CT - Green	6639-222
(A) '14 XF, XF CC, XF CT; '12-'13 XF; '13 XF CT - Orange	6639-223
(A) '14 XF HC, M, M HCR; '12-'13 M, M HCR, XF HC - Green	6639-224
(A) '14 XF HC, M, M HCR; '12-'13 M, M HCR, XF HC - Orange	6639-225
(B) '12-'14 F5, F570; '07-'11 F Series; '09-'11 Z1, Z1 Turbo	6639-226
(B) '08-'14 T570, TZ1, TZ1 LXR Touring; '09-'14 Bearcat 570	6639-227
(C) '14 ZR, ZR LXR, ZR SP; '12-'13 F 800, 1100, 1100T - Orange	6639-228
(D) '14 ZR, ZR LXR, ZR SP; '12-'13 F 800, 1100, 1100T - White	6639-229
(C) '14 XF, XF CC, XF CT; '12-'13 XF; '13 XF CT - Orange	6639-230
(D) '14 XF, XF CC, XF CT; '12-'13 XF; '13 XF CT - White	6639-231
(C) '14 XF HC, M, M HCR; '12-'13 M, M HCR, XF HC - Orange	6639-232
(D) '14 XF HC, M, M HCR; '12-'13 M, M HCR, XF HC - White	6639-233
(E) '14 ZR, ZR LXR, ZR SP; '12-'13 F 800, 1100, 1100T - Green	6639-220
(E) '14 ZR, ZR LXR, ZR SP; '12-'13 F 800, 1100, 1100T - Orange	6639-221
(F) '14 ZR, ZR LXR, ZR SP; '12-'13 F 800, 1100, 1100T	6639-234
(F) '14 XF, XF CC, XF CT; '12-'13 XF; '13 XF CT	6639-235
(F) '14 XF HC, M, M HCR; '12-'13 M, M HCR, XF HC	6639-236
(G) '14 ZR, ZR LXR, ZR SP; '12-'13 F 800, 1100, 1100T	6639-237

ABBREVIATION KEY

BC	Bearcat
CC	Cross Country
CF	Crossfire
CT	Crosstour
GS	Groomer Special
JR	Jaguar
HC	High Country
SP	Sno Pro
1100T	1100 Turbo



Page 103

TEAM ARCTIC CANVAS COVERS

Trailerable

Application	p/n
(J) '14 ZR, ZR LXR, ZR SP; '12-'13 F 800, 1100, 1100T	6639-274
(J) '10-'14 Sno Pro 500	6639-275



Page 104

ARCTIC CAT CANVAS COVERS

Trailerable

Application	p/n
(H) '14 ZR, ZR LXR, ZR SP; '12-'13 F 800, 1100, 1100T	6639-238
(H) '14 XF, XF CC, XF CT; '12-'13 XF; '13 XF CT	6639-239
(H) '14 ZR, XF, XF CC, XF CT; '12-'13 F; '13 XF CT w/2-Up Seat	6639-240
(H) '14 XF HC, M, M HCR; '12-'13 M, M HCR, XF HC	6639-241
(H) '12-'14 F5, F570; '07-'11 F Series; '09-'11 Z1, Z1 Turbo	6639-242
(I) '08-'14 T570, TZ1, TZ1 LXR Touring; '09-'14 Bearcat 570	6639-243
(I) '09-'14 BC 570 XT, BC Z1 XT; '12-'14 BC Z1 XT GS; '14 BC 570 XTE	6639-244
(H) '00-'14 120	6639-245

■NOTE: Bearcat Z1 XT GS model requires removal of light bar before installing cover.



Page 104

DUST COVER

Not Trailerable

Application	p/n
121"-129"	5639-705
136"-162" Mountain	5639-706
2-Up Touring	5639-716



Page 105

HALF COVER

Not Trailerable

Application	p/n
'14 ZR; '12-'14 M, XF w/Low & Mid WS w/o Mirrors	6639-202



Page 105

**CUSTOM COVERS
(NON-CURRENT SLED MODELS)**

Trailerable

Application	p/n
'03-'06 FC, SC 128"	5639-017
'99-'06 CO, EXT, T660, TC, Z, ZL, ZR, ZRT 121"	5639-018
'05-'11 M Series 153"-162"	5639-241
'02-'04 MC; '04-'06 KC	5639-019
'00-'06 2-Up PA, PTA, T660 Touring	5639-020
'03-'08 BC WT	5639-021
'06-'11 CF; '06-'07 M Series 141"	6639-044
'09-'11 CFR	6639-045
'06-'11 CF w/2-Up Seat	5639-283
'12-'14 F5, F570; '07-'11 F Series w/2-Up Seat	5639-286
'09-'11 Z1, Z1 Turbo w/2-Up Seat	5639-286
'10-'11 Z1 Turbo EXT; '11 F8 EXT	5639-547



Page 105

UNDERCOVER LINER

Application	p/n
Universal	5639-570



REPLACEMENT COVER STRAPS

Description	p/n
(A) Sew-On Straps w/Buckles (Pkg 4)	0636-610
(B) Cinch Straps w/Hook (Pkg 4)	0636-527

Touring Bags



Page 106

SADDLEBAGS

Application

'14 ZR 5000, 6000, 7000, 8000, 9000, XF 7000, 7000 CC, 7000 CT, 8000, 8000 CC, 8000 CT, 9000, 9000 CC, 9000 CT; '12-'13 F 800, 1100, 1100T, XF 800, 1100, 1100T; '13 XF 800 CT, 1100 CT, 1100T CT

p/n

6639-050

Replacement Hardware

Spool w/Rivet, Pair
Front Clip, Pair

6639-154

6639-155



Page 106

2-UP SADDLEBAGS

Application

'14 XF 7000 CT, 8000 CT, 9000 CT; '13 XF 800 CT, 1100 CT, 1100T CT w/2-Up Seat & Cargo Rack

p/n

6639-201

Replacement Hardware

Plastic Clips, Pair
Bracket, RH & LH
Knob, Pair

6639-393

6639-394

6639-395



Page 106

SEAT POCKET

Application

'14 ZR 6000, 8000, XF 8000, M 8000; '12-'13 F 800, XF 800, 800 HC, M 800, 800 HCR w/o Battery

p/n

6639-046



Page 106

SEAT PACK

Application

'14 ZR; '12-'14 M, XF; '12-'13 F All Models

p/n

6639-047

Replacement Hardware

Spool w/Rivet, Pair

6639-154

Front Clip, Pair

6639-155

Ladder Lock, Pair

6639-156

Strap w/Hook, Pk/4

0641-994



Page 106

A. TOURING SADDLEBAGS

Application

'08-'14 T 570, TZ1 Touring; '09-'14 BC 570; '08-'09 T500

p/n

4639-712

B. TOURING GEAR BAG

Application

'08-'14 T 570, TZ1 Touring; '09-'14 BC 570; '08-'09 T500

p/n

5606-171



Page 107

TUNNEL GEAR BAG

Application

(A) '14 ZR 5000, 6000, 7000, 8000, 9000, XF 7000, 7000 CC, 8000, 8000 CC, 9000, 9000 CC; '12-'13 F 800, 1100, 1100T, XF 800, 1100, 1100T
(B) '12-'14 F5, F570; '10-'11 F Series, M Series, Z1, Z1 Turbo, Z1 Turbo EXT; '11 F8 EXT

p/n

6639-276

5639-574

Replacement Hardware

Spool w/Rivet, Pair (6639-048, 6639-276)

6639-154

Front Clip, Pair (6639-048, 6639-276)

6639-155

Ladder Lock, Pair (6639-048, 6639-276)

6639-156

Strap w/Hook, Pk/4 (6639-048, 5639-574, 6639-276)

0641-994

Cam Buckle, Pair (5639-574)

0639-089

Base Plate w/Foam (5639-707)

6639-186

Tunnel Strap (See page 18)

6639-460

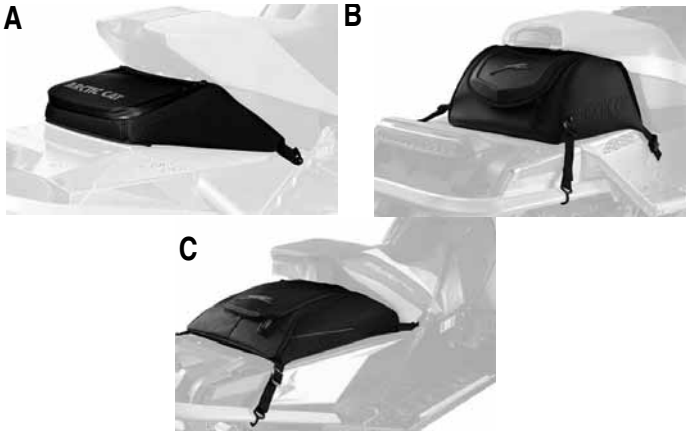

Page 107

TUNNEL PACK

Application	p/n
(A) '14 ZR 5000, 6000, 7000, 8000, 9000, XF 7000, 7000 CC, 8000, 8000 CC, 8000 HC, 9000, 9000 CC, 9000 HC, M 8000, 8000 HCR, 9000, 9000 HCR; '12-'13 F 800, 1100, 1100T, XF 800, 800 HC, 1100, 1100T, 1100T HC, M 800, 800 HCR, 1100, 1100T, 1100T HCR	6639-183
(B) '12-'14 F5, F570; '10-'11 F Series, Z1, Z1 Turbo, Z1 Turbo EXT; '11 F8 EXT	5639-573
(C) '10-'14 Sno Pro 500, '10-'11 M Series	5639-433
Replacement Hardware	
Spool w/Rivet, Pair (6639-183)	6639-154
Front Clip, Pair (6639-183)	6639-155
Strap w/Hook, Pk/4 (5639-433, 5639-573)	0641-994
Cam Buckle, Pair (5639-573)	0639-089



Page 108

TUNNEL CARGO BAG

Application	p/n
'14 ZR 5000, 6000, 7000, 8000, 9000, XF 7000, 7000 CC, 8000, 8000 CC, 9000, 9000 CC; '12-'13 F 800, 1100, 1100T, XF 800, 1100, 1100T	6639-277
Replacement Hardware	
Spool w/Rivet, Pair	6639-154
Front Clip, Pair	6639-155



Page 108

CROSTOUR RACK BAG

Fits accessory Cargo Rack (See page 20)

Application	p/n
'14 XF 7000 CT, 8000 CT, 9000 CT; '13 XF 800 CT, 1100 CT, 1100T CT	6639-112



Page 108

GOGGLE HOLDER

Application	p/n
'14 ZR; '12-'14 M, XF; '12-'13 F All Models	5639-767
Replacement Hardware	
Latch Repair Kit	6639-076



Page 108

HOOD PACKS

Sold as a pair.

Application	p/n
'14 ZR; '12-'14 M, XF; '12-'13 F All Models	6639-097
Replacement Hardware	
Plastic Rivets (Pk/6)	5639-930

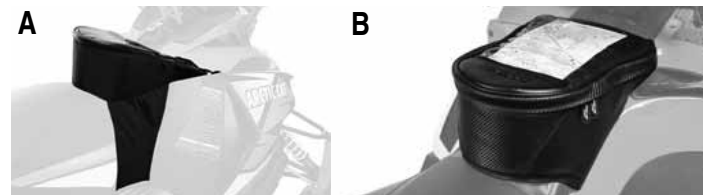

Page 108

TANK BAG

Application	p/n
(A) '14 ZR; '12-'14 XF; '12-'13 F All Models	6639-200
(B) '12-'14 F5, F570; '07-'11 F Series; '08-'14 T 570, TZ1 Touring; '09-'14 BC 570; '09-'11 Z1, Z1 Turbo; '08-'09 T500	4639-426
Replacement Hardware	
Channel w/Velcro, Pair (6639-200)	6639-187

p/n 6639-278, 5639-712



p/n 4639-714



p/n 3639-962



Page 109

WINDSHIELD BAG

Small bag (A) fits all windshields. Large bag (B) fits Accessory mid and high windshields.

Application

	p/n
(A) '14 ZR 5000, 6000, 8000, 9000, XF 8000, 8000 CC, 8000 CT, 8000 HC, 9000, 9000 CC, 9000 CT, 9000 HC, M 8000, 8000 HCR, 9000, 9000 HCR; '12-'13 F 800, 1100, 1100T, XF 800, 800 HC, 1100, 1100T, 1100T HC, M 800, 800 HCR, 1100, 1100T, 1100T HCR; '13 XF 800 CT, 1100 CT, 1100T CT	5639-712
(B) '14 ZR 5000, 6000, 8000, 9000, XF 8000, 8000 CC, 8000 CT, 8000 HC, 9000, 9000 CC, 9000 CT, 9000 HC, M 8000, 8000 HCR, 9000, 9000 HCR; '12-'13 F 800, 1100, 1100T, XF 800, 800 HC, 1100, 1100T, 1100T HC, M 800, 800 HCR, 1100, 1100T, 1100T HCR; '13 XF 800 CT, 1100 CT, 1100T CT	6639-051
(A) '14 ZR 7000, XF 7000, 7000 CC, 7000 CT	6639-278
(B) '14 ZR 7000, XF 7000, 7000 CC, 7000 CT	6639-279
'12-'14 F5, F570; '08-'14 T570, TZ1 Touring; '09-'14 BC; '09-'11 F Series, Z1	4639-714
'09-'13 TZ1 Turbo Touring; '09-'11 Z1 Turbo	5639-304
'05-'11 M Series; '06-'11 CF; '09-'11 CFR, M8 HCR	4639-428
'03-'06 FC; '04-'06 SC	3639-715
'00-'06 ZR; '01-'04 MC 600, 800, 900; '02-'05 PTA; '04-'06 KC; '03-'07 BC WT (Non-Turbo) Center Bag Only	3639-962

p/n 6639-279, 6639-051



p/n 3639-715



p/n 4639-428



A



B



C



Page 109

HANDLEBAR BAG

Application

	p/n
(A) '14 ZR 5000, 6000, 7000, 8000, 9000, XF 7000, 8000, 9000; '12-'13 F 800, 1100, 1100T; '08-'14 T570, TZ1 Touring; '12-'14 F5, F570; '07-'11 F Series, Z1	6639-468
(B) '14 XF 7000 CC, 7000 CT, 8000 CC, 8000 CT, 8000 HC, 9000 CC, 9000 CT, 9000 HC, M 8000, 8000 HCR, 9000, 9000 HCR; '12-'13 XF 800, 1100, 1100T, M 800, 800 HCR, 1100, 1100T, 1100T HCR; '13 XF 800 CT, 1100 CT, 1100T CT	6639-469
(C) '10-'14 Sno Pro 500	5639-434

Page 109

CUSTOM HANDLEBAR BAG

Application

	p/n
Universal	5639-041



Page 109

BAG HEATER KIT

Application

	p/n
Fits Handlebar Bags 6639-468, 6639-469, 5639-708, 5639-709	5639-837





Page 110

SEMI-RIGID MUFFS

Application **p/n**
 Universal 5639-713



Page 110

SOFT MUFFS

Application **p/n**
 Universal 6639-280



Page 110

SPORT MUFFS

Application **p/n**
 (A) '14 ZR; '12-'14 M, XF; '12-'13 F All Models 5639-714
 (B) '07-'11 Models 5639-524



WINDSHIELD FLAIR BAGS

Sold as a pair.

Application **p/n**
 '00-'06 ZR; '01-'04 MC; '01-'07 Z; '02-'05 PTA; 4639-427
 '04-'06 KC; '03-'08 BC 570, PA



FIRECAT TRUNK BAG

Application **p/n**
 '03-'06 FC 128" 3639-722
Replacement Hardware
 Cam Buckle, Pair 1639-248



TANK JACKET

Application **p/n**
 '05-'11 M Series; '09-'11 M8 HCR 5639-053
 '06-'11 CF; '09-'11 CFR 5639-056
 Velcro (Pair) 4639-602



UNDERHOOD BAG

Application **p/n**
 '09-'14 TZ1 Touring; '09-'11 Z1 (Non-Turbo) 5639-305

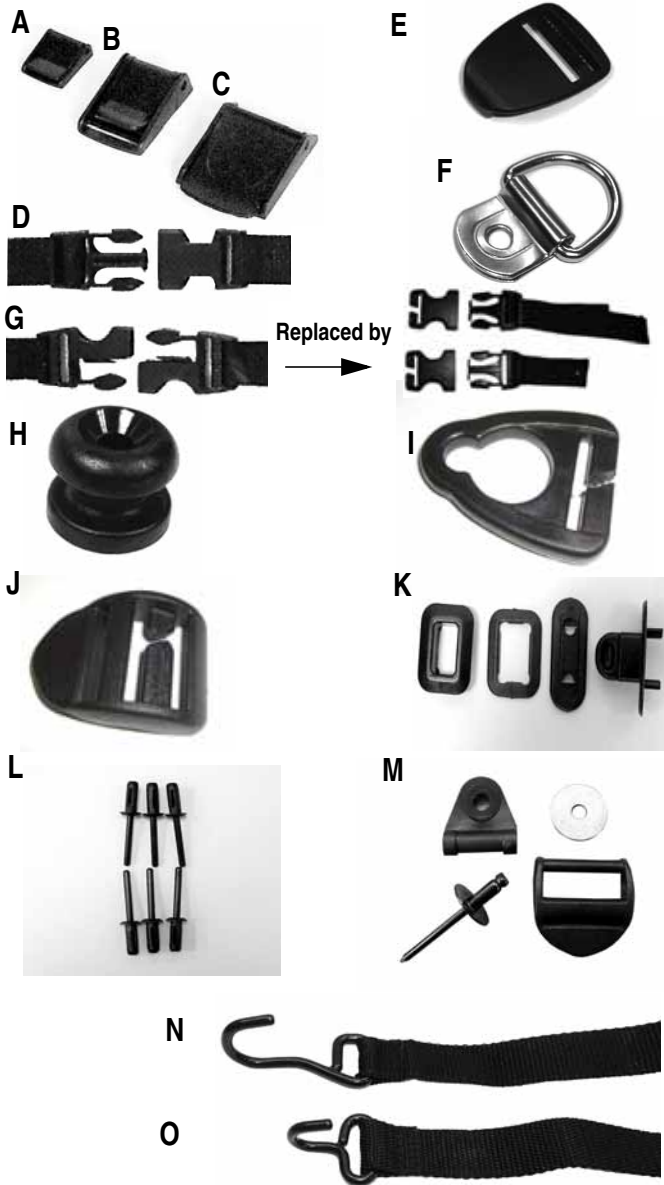

REPLACEMENT BAG HARDWARE

Description	p/n
(A) Cam Buckle (Pair) - 1"	0639-089
(B) Cam Buckle (Pair) - 1-1/2"	1639-248
(C) Cam Buckle (Pair) - 2"	2639-152
(D) Side Release Buckle Kit (Pair)	0638-082
(E) Strap Hook (Pair)	0641-485
(F) Tunnel Clip - Black (Each)	6606-244
(G) Buckle Kit - Unisex Replacement (Pair)	2639-662
(H) Spool (Pair)	6639-154
(I) Bag Clip (Pair)	6639-155
(J) Ladder Lock (Pair)	6639-156
(K) Latch Repair Kit (5639-767)	6639-076
(L) Plastic Rivets (Pk/6)	5639-930
(M) Buckle Repair Kit (Pk/4)(5639-710, 6639-401)	6639-545
(N) Cover Straps (Pk/4)	0636-527
(O) Bag Straps (Pk/4)	0641-994

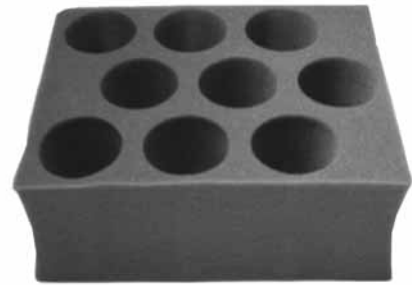

FOAM BEVERAGE HOLDER

Description
Universal 11"x 9"x 4"

p/n
1639-599



TUNNEL STRAP

Mounts to the tunnel and straps over storage bags. Provides added security when carrying heavy loads or operating in rough terrain.

Description
Strap with mounting hardware

p/n
6639-460

Touring Accessories

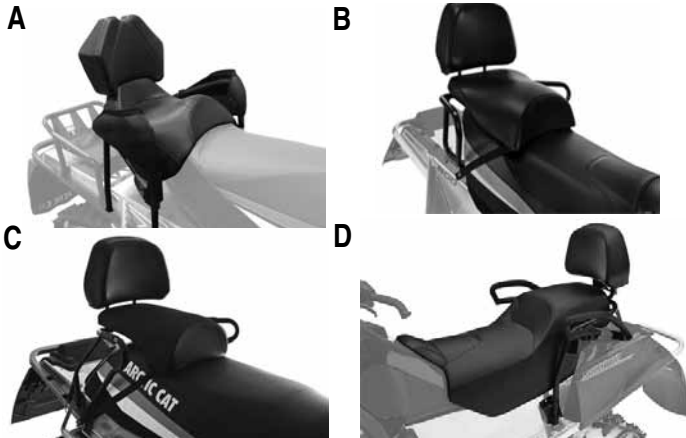

Page 111

2-UP SEAT KIT

■NOTE: '13-'14 XF Crosstour models have a standard hitch with the mounting pockets required for the 2-Up Seat

Application	p/n
(A)'14 ZR 5000, 6000, 8000, 9000, XF 8000, 8000 CT, 9000, 9000 CT; '12-'13 F 800, 1100, 1100T, XF 800, 1100, 1100T; '13 XF 800 CT, 1100 CT, 1100T CT (Requires Hitch Kit)	6639-467
(A)'14 ZR 7000, XF 7000, 7000 CT (Requires Hitch Kit)	6639-515
(B)'12-'14 F5, F570; '10-'11 F Series, Z1, Z1 Turbo, Z1 Turbo EXT; '11 F8 EXT (Requires Tunnel Rails)	5639-307
(C)'09-'11 CF, CFR (Requires Hitch Kit)	5639-308
(D)'09 F Series (Liquid-Cooled), Z1, Z1 Turbo	5639-150

Page 111

HAND WARMER KIT

Application	p/n
Fits 2-Up Seat Kits 6639-515, 6639-467, 5639-717	6639-281



Page 111

PASSENGER HAND MUFFS

Application	p/n
'08-'14 T570, TZ1 Touring; '09-'14 BC 570, BC XT	5639-353



Page 112

PRO BUMPER

Application	Color	p/n
'14 ZR; '12-'14 M, XF; '12-'13 F All Models	Brushed	6639-053
	Black	6639-054
	Green	6639-283
	Orange	6639-056
	White	6639-284
Replacement Mounting Hardware		6639-600



Page 112

PROCLIMB BUMPER

Application	Color	p/n
'14 ZR; '12-'14 M, XF; '12-'13 F All Models	Brushed	6639-285
	Black	6639-286
	Green	6639-287
	Orange	6639-288
	White	6639-289
Replacement Mounting Hardware		6639-602



Page 112

PROCROSS BUMPER

Application	Color	p/n
'14 ZR; '12-'14 M, XF; '12-'13 F All Models	Brushed	6639-290
	Black	6639-291
	Green	6639-292
	Orange	6639-293
	White	6639-294
Replacement Mounting Hardware		6639-601

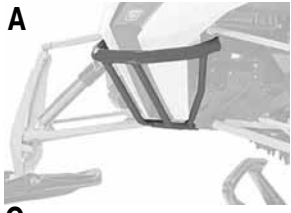

Page 112

SPORT BUMPERS

Application	Color	p/n
(A) '14 ZR 5000, 6000, 7000, 8000, XF 7000, 7000 CC, 8000, 8000 CC, 8000 HC, M 8000, 8000 HCR; '12-'13 F 800, 1100, XF 800, 800 HC, 1100, M 800, 800 HCR, 1100	Black TA Green PC Green Orange White	5639-850 6639-282 5639-851 5639-852 6639-094
(B) '12-'14 F5, F570; '08-'14 T570, TZ1 Touring; '09-'14 BC 570; '09-'11 Z1, Z1 Turbo; '07-'11 F Series	Black Green Orange	5639-825 5639-826 5639-827
(C) '10-'14 Sno Pro 500	Green	5639-065
(D) '12-'13 Sno Pro 600	Black	5639-994



TOURING BUMPER - STEEL

■NOTE: Top tube interferes with hood removal on turbo models.

Application	Color	p/n
'12-'14 F5, F570; '08-'14 T570, TZ1 Touring; '09-'14 BC 570; '09-'11 Z1 (Non-Turbo); '07-'11 F Series	Black	5639-312

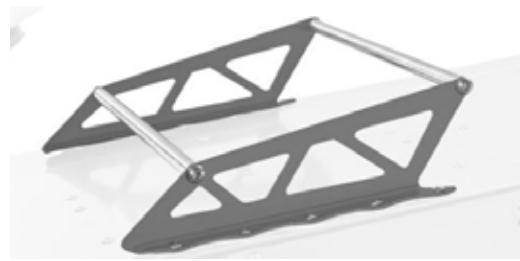

Page 113

PROCLIMB RACK

Fits models with Flat tunnel
8" x 11½" w

Application
'14 ZR; '12-'14 M, XF; '13 F w/Flat Tunnel

Color	p/n
Black	6639-159
Green	6639-297
Orange	5639-774
Silver	5639-775

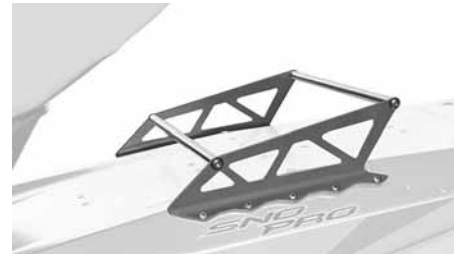

PROCROSS RACK

8" x 11½" w

Application	Color	p/n
'12 F 800, 1100, 1100T, XF 800, 1100, 1100T w/Original Tunnel	Black Green Orange Silver	6639-158 5639-718 5639-719 5639-720



Page 113

CARGO RACK

Requires Hitch Kit with eight mounting pockets. 11" x 14" w

Application	Color	p/n
'14 ZR 5000, 6000, 7000, 8000, 9000, XF 7000, 7000 CC, 8000, 8000 CC, 8000 HC, 9000, 9000 CC, 9000 HC, M 8000, 9000 153; '12-'13 F 800, 1100, 1100T, XF 800, 800 HC, XF 1100, 1100T, 1100T HC, M 153"	Black Green Orange Silver	6639-057 6639-298 6639-059 6639-060

Rack Bag (See page 15)

6639-112



Page 113

TUNNEL RAILS

Includes mounting pockets for 2-up seat and rack. Sold in pairs.

Application

'12-'14 F5, F570; '10-'11 F Series, Z1, Z1 Turbo
'10-'11 Z1 Turbo EXT; '11 F8 EXT

p/n

5639-347
5639-348



CROSSFIRE RACK

Requires Hitch Kit with mounting pockets.

Application

'09-'11 CF, CFR

Color

Unpainted

p/n

5639-157



SPORT RACK

Mounts directly to the tunnel, or quick-attach to Tunnel Rails.

Application

'12-'14 F5, F570; '10-'11 F Series, Z1, Z1 Turbo,
Z1 Turbo EXT; '11 F8 EXT

Color

Unpainted

p/n

5639-315



TOURING RACK

Application

'08-'14 T570, TZ1 Touring; '09-'14 BC 570

Style

(A) Short 5639-316
(B) Long 5639-317



Page 113

HITCH KITS - PIVOT

Hitch Kits with eight mounting pockets will accept both a 2-Up Seat and a Cargo Rack.

■NOTE: 2012 F and XF models with a 2013 Tunnel Upgrade kit require a 2013 Hitch Kit.

Application

'14 ZR 5000, 6000, 7000, 8000, 9000; '13 F 800, 1100, 1100T 129" (Inc 8 Mounting Pockets)	6639-181
'12 F 800, 1100, 1100T 128" (Inc 8 Mounting Pockets)	6639-061
'14 XF 7000, 8000, 9000 137", XF 7000 CC, 8000 CC, 9000 CC 141"; '13 XF 800, 1100, 1100T 141" (Inc 8 Mounting Pockets)	6639-302
'12 XF 800, 1100, 1100 T 141" (Inc 8 Mounting Pockets)	6639-062
'14 XF 7000 CT, 8000 CT, 9000 CT; '13 XF 800 CT, 1100 CT, 1100T CT (Hitch Components Only)	6639-098
'14 XF 8000 HC, 9000 HC, M 8000, 8000 HCR, 9000; '12-'13 M 800, 800 HCR, 1100, 1100T, XF 800 HC, 1100T HC 153" (Inc 8 Mounting Pockets)	6639-087
'14 M 8000, 9000, 9000 HCR; '12-'13 M 800, 1100T, 1100T HCR 162"	5639-724
'12-'14 F5, F570; '10-'11 F Series, Z1, Z1 Turbo 128"	5639-318
'08-'14 T570, TZ1 Touring; '09-'14 BC 570	4639-723
'09-'11 M Series; '10 M8 HCR 153"	5639-158
'09-'11 M Series 162"; '11 M8 HCR 153"	5639-159
'09-'11 CF 141" (Inc 8 Mounting Pockets)	5639-166
'09 F Series, Z1, Z1 Turbo 128"	4639-966
'07-'08 JR; '07-'08 F Series (Liquid-Cooled)	4639-452
'03-'06 FC; '04-'06 SC 128" & 144"	2639-686
'00-'05 PTA; '04-'07 T660 Touring	1639-607
'99-'02 PA; '99-'06 121" Models; '07 Z, T660 Trail	1639-507

HITCH KIT - PINTLE

Application

'08-'14 T570, TZ1 Touring

p/n

4639-907



Page 113

PINTLE CONVERSION KIT

Application

Fits Pivot Hitch Kits

p/n

3639-189

A



B



REMOTE START KIT

Application

'08-'14 TZ1, TZ1 Turbo; '09-'14 BC Z1 XT; '09-'11 Z1, Z1 Turbo

p/n

5639-531

Replacement Transmitter

All Production and Accessory Remote Start Kits

(A) 2 Button

0630-146

(B) 3 Button

0630-187

Replacement Battery A23S 12V (purchase locally)

■ **NOTE:** For programming instructions, please visit [Cat Tracker Online](#).

A



B



C



D



Page 113

TOW HITCH

Light duty use.

Application

(A) '14 ZR; '12-'14 M, XF; '12-'13 F All Models

p/n

6639-541

(B) '12-'14 F5, F570; '09-'11 CF, CFR, M Series; '10-'11 F Series, Z1, Z1 Turbo, Z1 Turbo EXT; '11 F8 EXT

5639-324

(C) '05-'08 M Series; '06-'08 CF

4639-124

(D) '99-'06 121" Models; '07 Z, T660 Trail

1639-505

Page 114

DC POWER KIT

Application

'14 8000 Models Without Electric Start

p/n

6639-299

'14 8000 Models With Electric Start

6639-354

'12-'13 F 800, M 800, XF 800, XF 800 HC

5639-858

'09-'11 CF, CFR, M Series 800, 1000

5639-258



Page 114

ELECTRIC START KIT

For replacement parts, see appropriate parts manual.

Application

'14 ZR 8000, XF 8000, 8000 CC, 8000 HC, M 8000 (Std); '12-'13 F 800, XF 800, 800 HC, M 800, 800 HCR

p/n

6639-604

'14 BC 570 XTE

6639-626

'09-'10 F Series 800, 1000

5639-198

'08-'11 CF, M Series 500, 600

4639-803



Page 114

HEATED SEAT KIT

■ **NOTE:** Not available for 2-stroke - power output insufficient.

Application

'14 ZR 5000, 9000, XF 9000, 9000 CC

p/n

6639-465

'14 ZR 7000, XF 7000, 7000 CC

6639-466

'12-'13 F 1100, F 1100 Turbo, XF 1100, XF 1100 Turbo

5639-828

'14 M 9000 (Std); '12-'13 M 1100, M 1100 Turbo

5639-829

'09-'14 BC Z1 XT (Driver & Passenger)

4639-971

'11-'14 BC Z1 XT LTD (Passenger Only)

5639-638



Page 114

TETHER SWITCH

Application	p/n
'14 ZR 8000, XF 8000, 8000 CC, 8000 CT, 8000 HC, M 8000; '12-'13 F 800, M 800, XF 800, 800 HC	5639-859
'14 ZR 5000, 7000, 9000, XF 7000, 7000 CC, 7000 CT, 9000, 9000 CC, 9000 CT, 9000 HC, M 9000; '12-'13 F 1100, 1100T, M 1100, 1100T, XF 1100, 1100T, 1100T HC	5639-860
'07-'11 F Series Std & Sno Pro; '08-'11 CF, M Series; '09-'11 CFR; '99-'07 Normally Open Circuits	4639-140
'07-'11 F LXR; '07-'12 T570	4639-784
Normally Closed Circuits	0638-887
Replacement Tether Cord	0709-055

A



B



Page 114

ENGINE HEATER

U.S. and Canada.

Application	p/n
(A) '14 ZR 5000, 9000, XF 9000, 9000 CC, 9000 CT, 9000 HC, M 9000, 9000 HCR; '12-'13 F 1100, 1100T, M 1100, 1100T, 1100T HCR, XF 1100, 1100T, 1100T HC	5639-861
(B) '07-'14 TZ1; '09-'14 BC Z1 XT; '09-'13 TZ1 Turbo; '09-'11 Z1, Z1 Turbo	5639-823
'99-'07 LC Models Except CF, F, FC, JR, M, SC, 4-Stroke	0638-188

BATTERIES

Application	Year	p/n
BC 570	'09-'14	0745-047
	'04-'08	0745-059
BC 570 XT	'09-'14	0745-047
BC Z1 XT	'09-'14	0645-480
BC Z1 XT GS	'12-'14	0645-480
CF 500	'07-'09	0645-480
CF 600	'06-'11	0645-480
F5	'07-'14	0745-047
F570	'08-'14	0745-047
F6	'07-'11	0745-047
F8, F 1000	'07-'11	0645-480
F 800	'12-'13	0645-480
F 1100, F 1100T	'12-'13	0645-480
M 8000, 9000	'14	0645-480
M 800	'12-'13	0645-480
M 1100, 1100T	'12-'13	0645-480
M6	'05-'11	0645-480
T500	'08-'09	0745-047
T570	'08-'14	0745-047
TZ1 Touring	'08-'14	0645-480
TZ1 Turbo Touring	'09-'13	0645-480
XF 7000, 8000, 8000, 9000	'14	0645-480
XF 800	'12-'13	0645-480
XF 1100, 1100T	'12-'13	0645-480
Z1, Z1 Turbo	'09-'11	0645-480
ZR 5000, 6000, 7000, 8000, 9000	'14	0645-480

Windscreens

Page 118

	'14 ZR 5000, ZR 6000, ZR 8000 ZR 9000, XF 8000, XF 9000 M 8000, M 9000 '12-'13 F 800, F 1100, F 1100T M 800, M 1100, M 1100T XF 800, XF 1100, XF 1100T			'14 ZR 7000, XF 7000 XF 7000 CC, XF 7000 CT			'12-'14 F5, F570 '07-'11 F Series; '09-'11 Z1 '09-'14 BC, BC XT, TZ1			'05-'11 M Series; '06-'11 CF '09-'11 CFR, M8 HCR		
Extreme Low	p/n	Height	Width	p/n	Height	Width	p/n	Height	Width	p/n	Height	Width
Black	6639-303	9"	15 1/2"	6639-324	8"	15 1/2"				5639-525		
White	6639-304	9"	15 1/2"	6639-325	8"	15 1/2"				5639-526		
Flyscreens												
Black, Pride	6639-305	10"	15 1/2"	6639-326	11"	15 1/2"				5639-140	12'	25 1/2"
Green, Pride	6639-306	10"	15 1/2"	6639-327	11"	15 1/2"				5639-138	12'	25 1/2"
Orange, Pride	6639-307	10"	15 1/2"	6639-328	11"	15 1/2"				5639-139	12'	25 1/2"
Black, Team Arctic	6639-308	10"	15 1/2"	6639-329	11"	15 1/2"						
Green, Team Arctic	6639-309	10"	15 1/2"	6639-330	11"	15 1/2"						
Orange, Team Arctic	6639-310	10"	15 1/2"	6639-331	11"	15 1/2"						
White, Team Arctic	6639-311	10"	15 1/2"	6639-332	11"	15 1/2"						
Split Green/White	6639-194	10"	15 1/2"									
Black, No Graphic	6639-071	10"	15 1/2"									
Windscreens												
Low, Black, Pride	6639-312	12"	20"	6639-333	13"	20"	5639-130	7 1/2"	29"	5639-136	14 1/2"	27 3/4"
Low, Green, Pride	6639-313	12"	20"	6639-334	13"	20"	5639-128	7 1/2"	29"			
Low, Orange, Pride	6639-314	12"	20"	6639-335	13"	20"	5639-129	7 1/2"	29"			
Low, Black, Team Arctic	6639-315	12"	20"	6639-336	13"	20"						
Low, Green, Team Arctic	6639-316	12"	20"	6639-337	13"	20"						
Low, Orange, Team Arctic	6639-317	12"	20"	6639-338	13"	20"						
Low, White, Team Arctic	6639-318	12"	20"	6639-339	13"	20"						
Windshields												
Mid, Tint, Black	6639-319*	18"	30"	6639-340*	18"	30"	5639-439	12"	33"	4639-203	16"	29 3/4"
Mid, Tint, Green	6639-320*	18"	30"	6639-341*	18"	30"						
Mid, Tint, Orange	6639-321*	18"	30"	6639-342*	18"	30"						
Mid, Tint, Pink	6639-322*	18"	30"	6639-343*	18"	30"						
High, Tint, Black	6639-323*	20"	32"				4639-719	15 1/4"	33"	4639-227	18 1/2"	29 3/4"
High, Clear, Black				6639-344*	21"	32"						
Extreme High, Clear	6639-078*	21"	32"				5639-222**	20 1/2"	33"			

*Mid, High, and Extreme High Windshields are not recommended for '12-'14 models with Vertical Steering (See Note) **Requires Brace Kit (5639-628)

Production Windshields									
Sno Pro, Black	6606-376	8 1/2"	20"						
Sno Pro, Green	6606-481	8 1/2"	20"						
Sno Pro, Orange	6606-482	8 1/2"	20"						
Sno Pro, White	6606-578	8 1/2"	20"						
Mid, Black	6606-134	13 1/2"	25 1/2"						
Mid, Green	6639-214	13 1/2"	25 1/2"	6639-355	13 1/2"	25 1/2"			
Mid, Orange	6639-215	13 1/2"	25 1/2"	6639-356	13 1/2"	25 1/2"			
Mid, White	6639-216	13 1/2"	25 1/2"	6639-357	13 1/2"	25 1/2"			
Cross Country, Tint (Opt)	6606-513	16 1/2"	25 1/2"						
LXR, Tint	6606-377	16 1/2"	27 1/2"						

Windshields	'10-'14 Sno Pro 500; '08-'11 Sno Pro 600			'09-'13 TZ1 Turbo; '09-'11 Z1 Turbo			'04-'06 KC; '01-'04 MC 500-900; '02-'05 PTA; '01-'08 PA; '01-'07 Z; '01-'03 ZL; '00-'06 ZR		
Low, Black							5639-221	12"	32"
Low, Green							2606-471	14 1/2"	31 1/2"
Mid, Tint	5639-615	13"	32"	6606-274***	10"	31"	2606-163	16"	33"
High, Tint				5639-154****	15"	31"			

Requires Brace Kit (5639-518) *Requires Brace Kit (5639-455)

Windshields	'03-'06 FC, SC			'99-'01 600 Touring, PTA; '99-'02 MC 1000; '99-'02 TC, ZRT			'98-'00 PS, Z, ZL; '98-'99 ZR		
Low, Tint							1606-818	12 1/4"	30 1/4"
Mid, Tint	3606-943	13 3/4"	31 3/4"	1606-323	14"	31"	1606-074	15 3/4"	28"
High, Tint				1606-541	17 1/2"	31"			

NOTE: Special Applications

'14 XF 8000 CT, XF 9000 CT; '13 XF 800 CT, XF 1100 CT, XF 1100T CT; Extreme High, Clear; 6639-573

'12-'14 Models with Vertical Steering (Except 7000); Mid, Tint; 6639-077

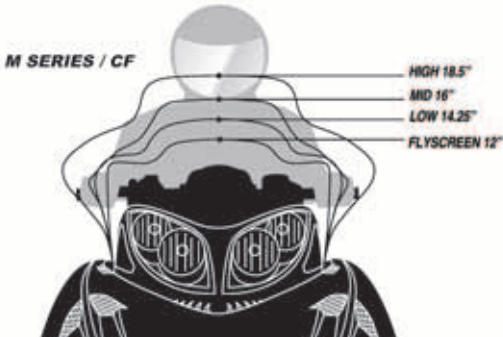
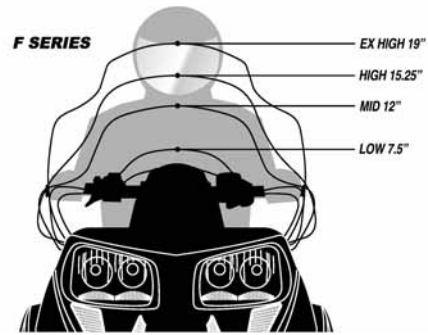
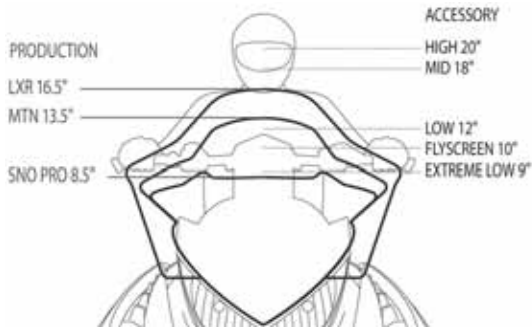

Measurements are taken vertically from dash panel to top of windshield. Style illustrations apply to indicated models only. Use reference point to determine style of windshield to order. Style of windshield for all other models is determined by measuring upward from lowest front center point on windshield to top center point. Accessory windshields do not have pre-drilled mirror mounting holes.

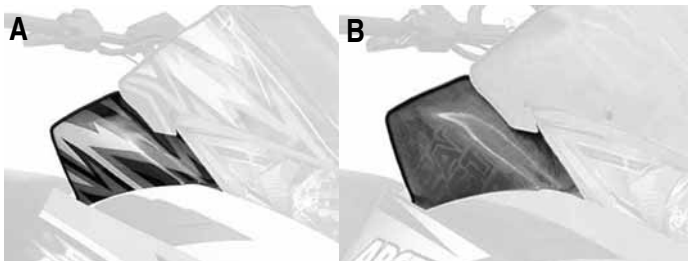

Page 119

SIDE DEFLECTORS

Application

'14 ZR; '12-'14 M, XF; '12-'13 F All Models

(A)Pride Graphic

Black	6639-347
Green	6639-348
Orange	6639-349

(B)Team Arctic Graphic

Black	6639-350
Green	6639-351
Orange	6639-352
White	6639-353

Solid Color, No Graphic

Black	5639-785
Green	6639-516
Orange	6639-517
White	6639-518

p/n

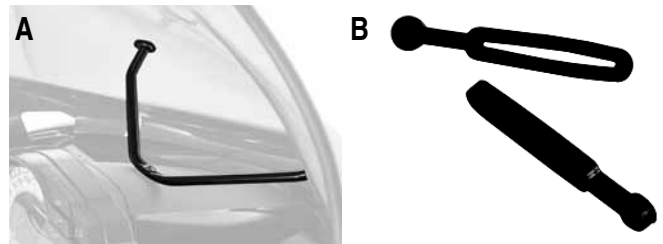

A. WINDSHIELD BRACE KIT

Application

Turbo Mid Windshield (6606-274)
Turbo High Windshield (5639-154)
Extreme High Windshield (5639-222)

p/n

5639-518
5639-455
5639-628

B. WINDSHIELD MOUNTING RING

Description

Universal (Each)

p/n

2606-853



WINDSHIELD DART

Description

Dart, Plastic (3/pk)

p/n

6639-217

Custom Accessories



Page 120

FOX ZERO-X

Sold in pairs.

Application	p/n
'14 ZR 5000, 6000, 7000, 8000, 9000, XF 7000, 7000 CC, 7000 CT, 8000, 8000 CC, 8000 CT, 8000 HC, 9000, 9000 CC, 9000 CT, 9000 HC; '12-'13 F 800, 1100, 1100T, XF 800, 1100, 1100T 42"	6639-211
'14 M 8000, 9000; '13 M 800, 1100, 1100T 38"	6639-212
'13 Sno Pro 600 43.5"	6639-215

C. FOX FLOAT R EVOL

Sold in pairs. Includes 300 psi pump.

Application	p/n
'14 ZR 5000, 6000, 7000, 8000, 9000, XF 7000, 7000 CC, 7000 CT, 8000, 8000 CC, 8000 CT, 8000 HC, 9000, 9000 CC, 9000 CT, 9000 HC; '12-'13 F 800, 1100, 1100T, XF 800, 1100, 1100T 42"	6639-438
'14 M 8000, 9000, 9000 HCR; '13 M 800, 1100, 1100T, 1100T HCR 38"	6639-437
'12 M 800, 1100, 1100T 40"	6639-478

D. FOX FLOAT X EVOL

Sold in pairs. Includes 300 psi pump.

Application	p/n
'14 ZR 5000, 6000, 7000, 8000, 9000, XF 7000, 7000 CC, 7000 CT, 8000, 8000 CC, 8000 CT, 8000 HC, 9000, 9000 CC, 9000 CT, 9000 HC; '12-'13 F 800, 1100, 1100T, XF 800, 1100, 1100T 42"	6639-439
'10-'14 Sno Pro 500	6639-479



Page 121

FOX FLOAT 3 REAR ARM

Application	p/n
'14 M 8000, 9000, XF 7000 CC, 8000 CC, 8000 HC, 9000 CC, 9000 HC; '12-'13 M 800, 1100, 1100T, XF 800, 1100, 1100T; '08-'11 M Series	6639-440



Page 120

A. FOX FLOAT 3

Sold in pairs. Includes 150 psi pump.

Application	p/n
'14 ZR 5000, 6000, 7000, 8000, 9000, XF 7000, 7000 CC, 7000 CT, 8000, 8000 CC, 8000 CT, 8000 HC, 9000, 9000 CC, 9000 CT, 9000 HC; '12-'13 F 800, 1100, 1100T, XF 800, 1100, 1100T 42"	6639-473
'14 M 8000, 9000; '13 M 800, 1100, 1100T 38"	6639-435
'12-'14 F5, F570; '07-'11 F Series; '09-'11 Z1, Z1 Turbo, Z1 Turbo EXT	6639-543
'05-'11 M Series	6639-474
'06-'11 CF; '09-'11 CFR	6639-475

B. FOX FLOAT EVOL

Sold in pairs. Includes 300 psi pump.

Application	p/n
'14 ZR 5000, 6000, 7000, 8000, 9000, XF 7000, 7000 CC, 7000 CT, 8000, 8000 CC, 8000 CT, 8000 HC, 9000, 9000 CC, 9000 CT, 9000 HC; '12-'13 F 800, 1100, 1100T, XF 800, 1100, 1100T 42"	6639-476
'14 M 8000, 9000; '13 M 800, 1100, 1100T 38"	6639-436
'12 M 800, 1100, 1100T 40"	6639-477



AIRSHOX PUMP

Application	p/n
Single Gauge 150 PSI (Float, Float 2, Float 3)	2603-614
Dual Gauge 100/300 PSI (Float Evol, Float R Evol, Float X Evol)	0641-257

Page 121

AIRSHOX GUARDS

Description	Color	p/n
Fox Float 2, Float 3, Float Evol, Float R Evol	Black	6639-080
	Green	6639-081
	Orange	6639-082
	White	6639-083



Page 122-123

CAT WRAPS

Includes RH & LH Graphics

'14 ZR; '12-'14 M, XF; '12-'13 F All Models

Hood Kit	p/n
(A) Strobe - Green	6639-358
(A) Strobe - Orange	6639-359
(B) Strobe - Pink	6639-360
(C) Scatter - Green	6639-361
(C) Scatter - Orange	6639-362
(D) Chaos - Green	6639-363
(D) Chaos - Orange	6639-364
(E) Black Magic	6639-365

'14 ZR; '12-'14 M; '13 F; '13-'14 XF w/Flat Tunnel

Tunnel Kit	p/n
(A) Strobe - Green	6639-366
(A) Strobe - Orange	6639-367
(B) Strobe - Pink	6639-368
(C) Scatter - Green	6639-369
(C) Scatter - Orange	6639-370
(D) Chaos - Green	6639-371
(D) Chaos - Orange	6639-372
(E) Black Magic	6639-373

'10-'14 Sno Pro 500

	p/n
(F) Chaos, Hood - Green	6639-470
(F) Chaos, Tunnel - Green	6639-471



Page 124

SUSPENSION BLOCKS

Application	p/n
Universal	
Black (Pair)	4639-853
Silver (Pair)	4639-855

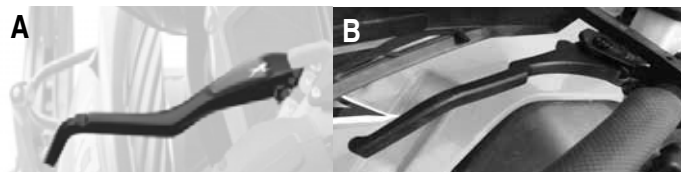

Page 124

SNO PRO LEVER

Description	Color	p/n
(A) '14 ZR; '12-'14 M, XF; '12-'13 F All Models	Black	5639-924
	Silver	5639-925
(B) '10-'14 Sno Pro 500	Black	5639-619
	Silver	5639-620

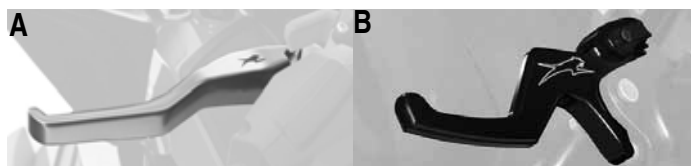

Page 124

BRAKE LEVER

Description	Color	p/n
(A) '14 ZR; '12-'14 M, XF; '12-'13 F All Models	Black	5639-736
	Silver	5639-737
(B) '12-'14 F5, F570; '07-'11 Models (Excludes Sno Pro 500)	Black	5639-505
	Silver	5639-506



Page 124

POD SCREWS

Sold in pairs.

Application	Color	p/n
'12-'14 F5, F570; '07-'11 F Series; '08-'14 T570, TZ1 Touring; '09-'14 BC 570; '09-'11 Z1, Z1 Turbo	Black	5639-593
	Silver	5639-594

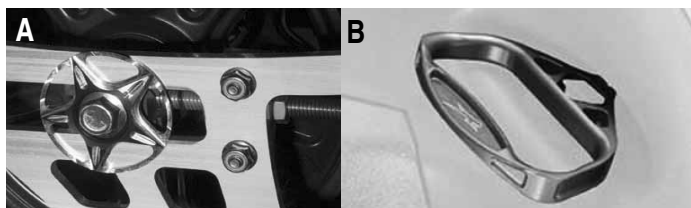

Page 124

A. AXLE WASHERS

Application	Color	p/n
'14 ZR; '12-'14 M, XF; '12-'13 F All Models	Black	5639-591
	Silver	5639-592

B. RECOIL HANDLE

Application	p/n
Universal	
Black	5639-452
Silver	5639-454

Sport Guards, Sno Pro and Arctic Cat Hand Guards include guards only. Mounting hardware is included in the Hand Guard Mount kit. Sold as pair. Requires low windshield.

■NOTE: Order Hand Guard Mounts to fit the specific model snowmobile. Then order Hand Guards to fit the mount style selected. Sno Pro Hand Guards fit mounts A, B, and C. Arctic Cat Hand Guards fit mounts D and E.

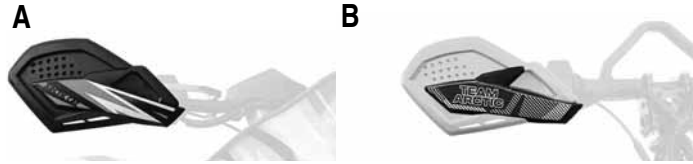

Page 125

SNO PRO HAND GUARDS

Description	p/n
(A) Pride Graphic	
Black	6639-376
Green	6639-377
Orange	6639-378
(B) Team Arctic Graphic	
Black	6639-379
Green	6639-380
Orange	6639-381
White	6639-382
Fits Mounts A, B, C	

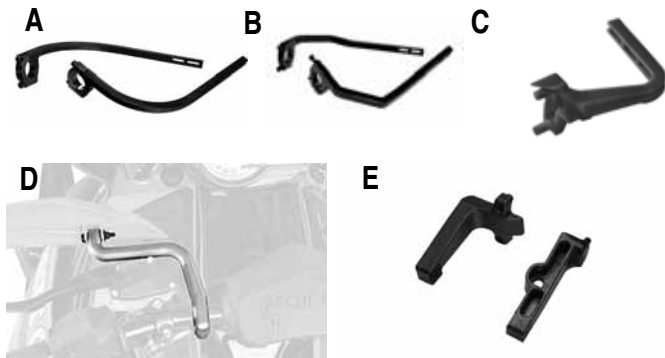

Page 125

HAND GUARD MOUNTS

Sold in pairs.

	'14 ZR '12-'13 F All Models	'12-'14 M, XF All Models	'10-'14 SP 500	'12 SP 600
	p/n	p/n	p/n	p/n
(A) Aluminum	5639-264		5639-264	5639-264
(B) Aluminum	6639-072		6639-072	6639-072
(C) Nylon	5639-763	5639-763		
	'12-'14 F5, F570 '09-'11 CFR '07-'11 F Series '09-'11 Z1, Z1 Turbo	'07-'11 CF '07-'11 M '09-'11 M8 HCR	'06 CF '05-'06 M '00-'02 ZR	'03-'06 FC '03-'06 ZR
	p/n	p/n	p/n	p/n
(A) Aluminum	5639-264			5639-264
(B) Aluminum	6639-072			6639-072
(C) Nylon	5639-763	5639-763		
(D) Aluminum	4639-805			4639-805
(E) Nylon	4639-804	4639-804	3639-077	

Replacement Hardware

For p/n 4639-804 0641-987
 For p/n 5639-264, 6639-072 0641-261
 For p/n 5639-763 0641-258

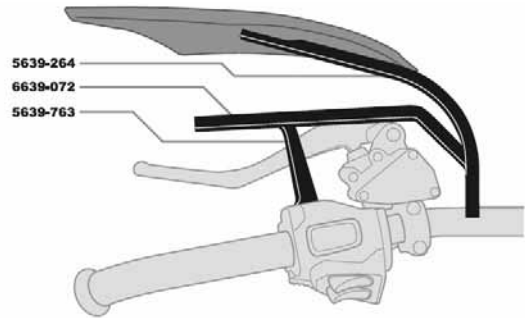

Page 125

SPORT GUARDS

Application
 Sport Guards
 Fits Mounts A & B

p/n
 6639-384



Page 125

HAND GUARD EXTENSIONS

Sold in pairs.

Application
 Sno Pro Hand Guards

p/n
 5639-263



Page 125

ARCTIC CAT HAND GUARDS

Description
 Black
 Green
 Orange
 Fits Mounts D & E

p/n
 4639-806
 4639-807
 4639-808

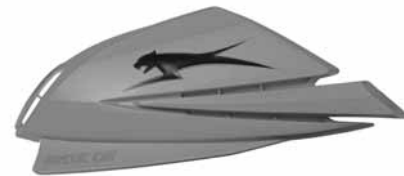



Page 125

HANDLEBAR GRIPS

Two 8" black grips. Cut to length.

Description
Black (Pair)

p/n
5639-655

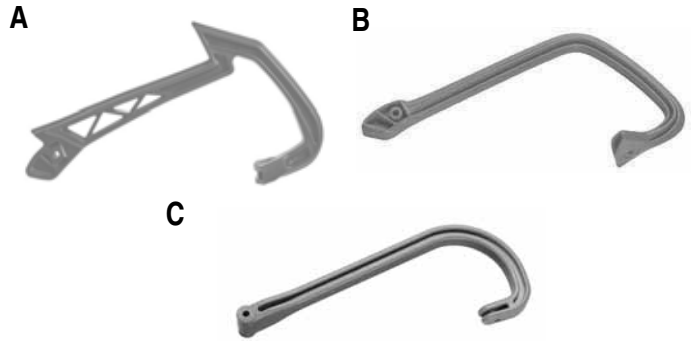

Page 126

ARCTIC CAT SKI HANDLES

Sold in pairs.

Description

p/n

(A) '12-'14 Arctic Cat Saddleless Skis

Team Arctic Green
Pearl Cat Green
Orange
White

6639-388
5639-743
5639-744
6639-095

(B) '05-'11 Arctic Cat Saddleless Skis

Green
Orange

3639-777
3639-778

(C) Arctic Cat Plastic Skis

Green
Orange

3639-781
3639-865

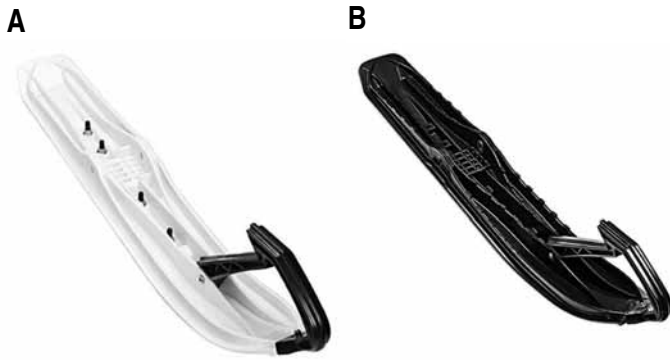

Page 126

ARCTIC CAT SADDLELESS SKIS

Includes 4" carbides. Fits all applications '97 & Newer. Sold in pairs.

Description

(A) 6" Ski Kit - Trail
(A) 6" Ski Kit - Trail
(B) 6" Ski Kit - Mountain (Standard Keel)
(B) 6" Ski Kit - Mountain (Standard Keel)
(B) 6" Ski Kit - Mountain (Competition Keel)
(B) 6" Ski Kit - Mountain (Competition Keel)
8" Ski Kit - Trail

Color

Black
White
Black
White
Black
White
Black

p/n

6639-206
6639-385
5639-877
6639-386
5639-878
6639-387
5639-323

Wearbars (See page 51 Ref A)



Page 126

SLP POWDER PRO SKIS™

Wearbars sold separately. 7" Ski width. Sold in pairs.

Application

'14 ZR; '12-'14 M, XF; '12-'13 F All Models

'12-'14 F5, F570; '07-'11 All Models
Wearbars (See page 51 Ref D)

Color

Black
White
Black

p/n

6639-091
6639-389
5639-326



C&A PRO ADX SKIS

Includes mounting hardware. Wearbars sold separately. 6" Ski width. Sold in pairs.

Application	Color	p/n
'14 ZR; '12-'14 M, XF; '12-'13 F All Models	Black	6639-345
'07-'11 Models	Black	5639-603
Wearbars (See page 51 Ref E)		



UNIVERSAL PLASTIC SKIS

Fits all '09 and earlier Arctic Cat independent front suspensions. Sold in pairs.

Description	Color	p/n
Ski Kit	Black	0639-225
Wearbars (See page 51 Ref B)		



C&A PRO RAZOR SKIS

Includes mounting hardware. Wearbars sold separately. 6" Ski width. Sold in pairs.

Application	Color	p/n
'14 ZR; '12-'14 M, XF; '12-'13 F All Models	Black	6639-590
	White	6639-591
'07-'11 Models	Black	6639-457
Wearbars (See page 51 Ref E)		



BLOW-MOLDED SKIS

Includes 4" carbides. Fits all '09 and earlier applications except cast aluminum spindle (see Universal Plastic skis). Sold in pairs.

Description	Color	p/n
5" Ski Kit - Black	Black	1639-575
Wearbars (See page 51 Ref C)		



C&A PRO MTX SKIS

Designed for 4-stroke mountain snowmobiles. Offers maximum floatation to help stay on top of the snow. Includes mounting hardware. Wearbars sold separately. 8" Ski width. Sold in pairs.

Application	Color	p/n
'14 ZR; '12-'14 M, XF; '12-'13 F All Models	Black	6639-592
	White	6639-593
Wearbars (See page 51 Ref E)		

SNOW MESH

Hood mesh not for use on Fan-Cooled Models.

Application

p/n

Bumper (Coarse Mesh)

'14 ZR 5000, 7000, 9000, XF 7000, 9000, 9000 CC, 9000 HC, M 9000, 9000 HCR; '12-'13 F 1100, 1100T, M 1100, 1100T, 1100T HCR, XF 1100, 1100T	5639-836
'12-'14 F5, F570; '07-'11 F Series; '08-'14 T570, TZ1 Touring; '09-'14 BC 570; '09-'11 Z1	5639-332
'09-'13 TZ1 Turbo; '09-'11 Z1 Turbo	5639-352
'05-'11 M Series; '06-'11 CF; '09-'11 CFR, M8 HCR	5639-169
'09-'14 BC 570 XT, BC Z1 XT; '12-'14 BC Z1 XT GS	5639-522

Hood (Coarse Mesh) (Liquid-Cooled Models)

'14 ZR 5000, 6000, 8000, XF 8000, 8000 CC, 8000 CT, 8000 HC, M 8000, 8000 HCR; '12-'13 F 800, 1100, XF 800, 800 HC, 1100, M 800, 800 HCR, 1100; '13 XF 800 CT, 1100 CT	6639-106
'14 ZR 9000, XF 9000, 9000 CC, 9000 CT, 9000 HC, M 9000, 9000 HCR; 6639-111	6639-111
'12-'13 F 1100T, M 1100T, 1100T HCR, XF 1100T, 1100T HC; '13 XF 1100T CT	6639-111
'12 F 800, 1100, 1100T, M 800, 800 HCR, 1100, 1100T, 1100T HCR, XF 800, 800 HC, 1100, 1100T, 1100T HC (LH Side Panel)	5639-835
'12 F 800, 1100, 1100T, XF 800, 800 HC, 1100, 1100T, 1100T HC, M 800, 800 HCR, 1100, 1100T, 1100T HCR (RH Side Panel)	6639-197
'12-'14 F5; '07-'11 F Series; '08-'14 TZ1 Touring; '09-'14 BC Z1 XT; '09-'11 Z1 (Non-Turbo)	5639-458
'05-'11 M Series; '06-'11 CF; '09-'11 CFR, M8 HCR	5639-333
'10-'14 Sno Pro 500	5639-396
'03-'06 FC, SC	5639-633

Intake (Fine Mesh)

'12-'13 F 800, F 1100, F 1000 Turbo, XF 800, XF 1100, XF 1100 Turbo	5639-947
'05-'11 M Series; '06-'11 CF; '09-'11 CFR, M8 HCR	5639-334

Side Panel, Rear (Coarse Mesh)

'09-'14 BC Z1 XT; '12-'14 BC Z1 XT GS	5639-499
---------------------------------------	----------

p/n 6639-106

p/n 6639-111



p/n 5639-522



p/n 5639-332

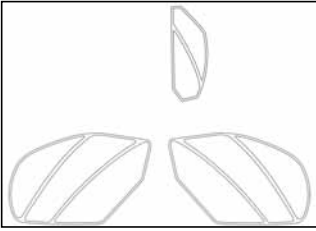

p/n 5639-352

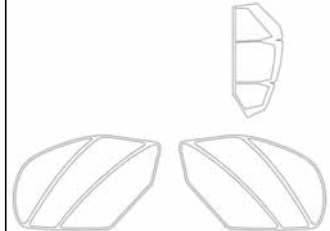

p/n 5639-169

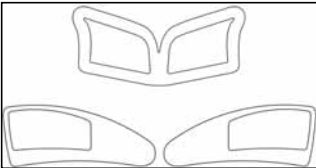

p/n 5639-333

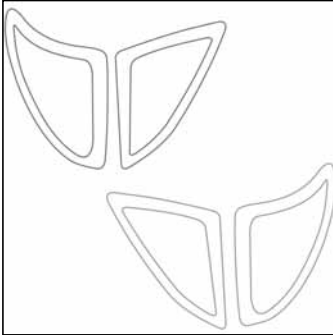

p/n 5639-458

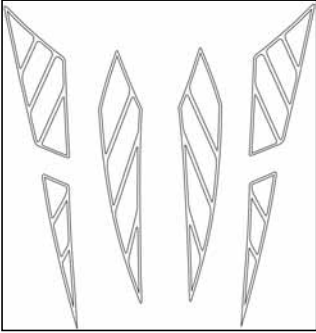

p/n 5639-334

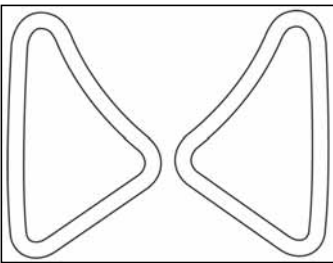

p/n 5639-396

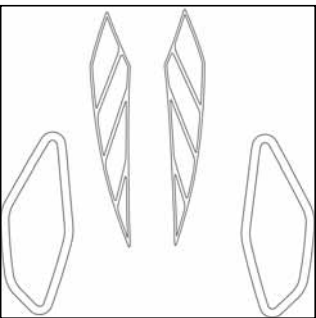

p/n 5639-499

p/n 5639-836

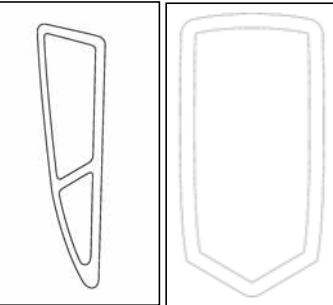

p/n 5639-633



p/n 5639-835, 6639-197

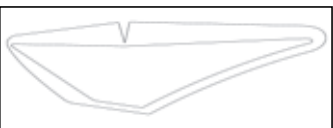

p/n 5639-947

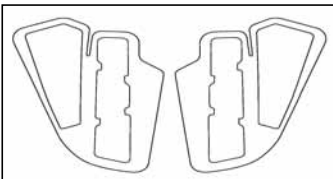

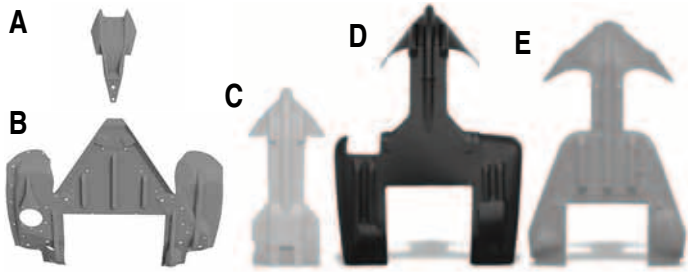

Page 127

SKID PLATES

Application	p/n
(A) '14 ZR 5000, 6000, 7000, 8000, XF 7000, 7000 CC, 8000, 8000 CC, 8000 HC, M 8000, 8000 HCR; '12-'13 F 800, 1100, XF 800, 800 HC, 1100, M 800, 800 HCR, 1100	
Black	5639-745
Team Arctic Green	6639-390
Orange	5639-747
White	5639-748
(B) '14 ZR 5000, 6000, 8000, 9000, XF 8000, 8000 CC, 8000 CT, 8000 HC, 9000, 9000 CC, 9000 CT, 9000 HC, M 8000, 8000 HCR, 9000, 9000 HCR; '13 F 800, 1100, 1100T, M 800, 800 HCR, 1100, 1100T, 1100T HCR, XF 800, 800 CT, 800 HC, 1100, 1100 CT, 1100T, 1100T CT, 1100T HC	
Black	6639-113
Team Arctic Green	6639-391
Orange	6639-115
White	6639-116
Replacement Hardware	1641-007
(B) '14 ZR 7000, XF 7000, 7000 CC, 7000 CT	
Black	6639-449
Team Arctic Green	6639-450
Orange	6639-451
White	6639-452
Replacement Hardware	1641-007
(B) '12 F800, 1100, 1100T, M800, 800 HCR, 1100, 1100T, 1100T HCR, XF 800, 800 HC, 1100, 1100T, 1100T HC	
Black	5639-893
Team Arctic Green	6639-392
Orange	5639-895
White	5639-896
Replacement Hardware	1641-007
(C) '05-'11 M Series; '06-'11 CF; '09-'11 CFR, M8 HCR	
Black	3639-838
Replacement Hardware	0641-719
(D) '05-'11 M Series; '06-'11 CF; '09-'11 CFR, M8 HCR	
Black - Heavy-Duty	5639-223
(E) '12-'14 F5, F570; '07-'11 F Series; '08-'14 T570, TZ1 Touring; '09-'14 BC 570; '09-'11 Z1, Z1 Turbo; '10-'11 Z1 Turbo EXT; '11 F8 EXT	
NOTE: '10-'11 Z1 models require trimming for exhaust outlet.	
Black	4639-567
Replacement Hardware	4639-684
'00-06 ZR; '01-'03 ZL; '01-'04 MC; '01-'08 Z; '04-'06 XC - No Photo	
Black	1639-417
Replacement Hardware	0641-508



Page 127

PROCROSS SEAT

Application	Color	p/n
Standard		
'12-'13 F 800, 1100, 1100T, XF 800, 1100, 1100T; '13 XF 800 CT	Black	6639-425
	Green	6639-426
	Orange	6639-427
Heated		
'12-'13 F 1100, 1100T, XF 1100, 1100T LXR; '13 XF 1100 CT, 1100 T CT Models w/Heated Seat	Black	6639-428
	Green	6639-429
	Orange	6639-430



Page 127

TUNNEL GRIPS

Application	p/n
'14 ZR; '12-'14 M, XF; '12-'13 F All Models	5639-839
Universal (Pair) 4.25" x 15.5"	5639-814



Page 128

HEADLIGHT COVERS

Not for use at night.

■NOTE: Some states and municipalities may have laws prohibiting the use of colored headlight covers. Please check state and local laws before using headlight covers. Arctic Cat Sales Inc. shall not be liable for any claims resulting from illegal use of headlight covers

Application	p/n
'14 ZR; '12-'14 M, XF; '12-'13 F All Models	
Chrome	5639-753
Green Chrome	5639-754
Smoke	5639-755
'12-'14 F5, F570; '07-'11 F Series; '10-'11 Z1, Z1 Turbo, Z1 Turbo EXT; '11 F8 EXT	
Chrome	5639-756
Green Chrome	5639-757
Smoke	5639-758
'05-'11 M Series; '06-'11 CF; '09-'11 CFR, M8 HCR	
Chrome	5639-759
Green Chrome	5639-760
Smoke	5639-761
Replacement Velcro Dots (8 pc)	4639-625



Page 128

SNOWFLAP

Application	p/n
'14 ZR; '12-'14 M, XF; '13 F w/Flat Tunnel	
Team Arctic Green	6639-398
Pearl Cat Green	5639-842
Orange	5639-843
'12 F 800, F 1100, F 1100T, XF 800, XF 1100, XF 1100T w/Std Tunnel	
Pearl Cat Green	5639-840
Orange	5639-841



Page 128

HOOD FLARES

Application	p/n
'14 ZR; '12-'14 M, XF; '12-'13 F All Models	
Black	5639-898
Team Arctic Green	5639-899
Orange	5639-900
White	6639-441

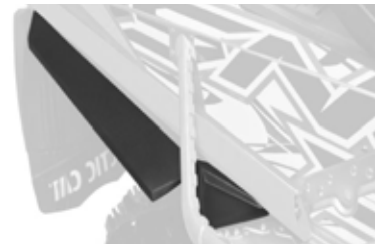

Page 128

TUNNEL FLARES

Application	p/n
'14 ZR; '12-'14 M, XF; '12-'13 F All Models	
Black	5639-809
Team Arctic Green	5639-810
Orange	5639-811
White	6639-442



Page 128

WHEEL KITS

5.35" wheels provide increased performance. Ice Scratchers may be required in low-snow conditions (See page 40).

Application	p/n
'14 ZR 5000, 6000, 7000, 8000, 9000 129"; '12-'13 F 800, 1100, 1100T (Two 5.63" Wheels w/Mounts)	6639-184
'14 ZR 5000, 6000, 7000, 8000, 9000 129"; '14 XF 7000, 8000, 9000 137"; '12-'13 F 800, 1100, 1100T (Four 5.35" Wheels w/Mounts)	6639-196
'14 ZR 5000, 6000, 7000, 8000, 9000 129"; '12-'13 F 800, 1100, 1100T (Eight 5.35" Wheels Four w/Mounts)	6639-185
'12-'13 Sno Pro 600 (5.63" Wheels w/Four Mounts)	5639-995
'08-'11 Sno Pro 600 SX (Four 5.63" Wheels w/Mounts)	4639-964



Page 128

PERFORMANCE WEARSTRIPS

Sold Individually.

Application	p/n
121"-141" Models	6639-448

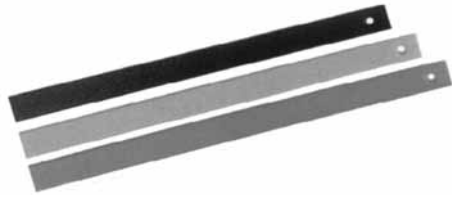

Page 128

WEAR STRIPS

Sold individually.

Application	p/n
121-129"	
Black	2604-257
Green	2604-819
Orange	2604-289
White	2604-543
136-162"	
Black	2604-799
Green	2604-821
Orange	1604-769
White	3604-832



Page 129

WIND DEFLECTORS

Application	p/n
'14 ZR; '12-'14 M, XF; '12-'13 F All Models	
Black	6639-453
Green	6639-535
Orange	6639-536
White	6639-537

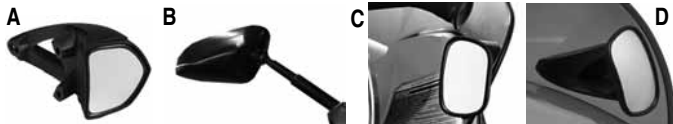

Page 129

A. WINDSHIELD MIRRORS

Application	p/n
'12-'14 F5, F570; '10-'11 F Series; '08-'14 T570, TZ1 Touring; '09-'11 Z1, Z1 Turbo; '10-'11 Z1 Turbo EXT; '11 F8 EXT	
Single	6639-629
Pair	6639-630

■NOTE: Fits '12-'14 F, M, XF, ZR w/accessory mid & high windshields.

B. HOOD-MOUNTED MIRRORS

Application	p/n
'14 ZR; '12-'14 M, XF; '12-'13 F All Models	
Single, RH	5639-830
Single, LH	5639-831
Pair	5639-832
Replacement Mounting Screw (Longer Thread Length)	1423-133

C.-D. COMPACT MIRRORS

Sold individually.

Application	p/n
(C) '05-'11 M Series; '06-'11 CF; '09-'11 CFR, M8 HCR	4639-463
(D) '12-'14 F5, F570; '10-'11 F Series; '08-'14 T570, TZ1 Touring; '09-'11 Z1, Z1 Turbo	4639-565

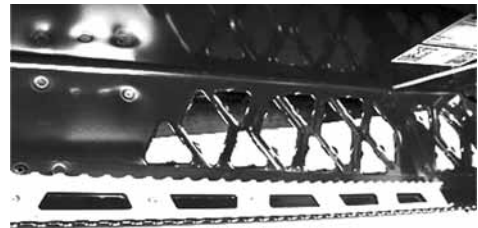

GRIP PLATES

Sold in pairs.

Application	Color	p/n
'12-'14 F5, F570; '10-'11 F Series; '10-'11 Z1, Z1 Turbo, Z1 Turbo EXT; '11 F8 EXT	Black	5639-328
	Green	5639-329



GRIPPER SEAT COVER

Application	p/n
'12-'13 F 800, F 1100, F 1100 Turbo, XF 800, XF 1100, XF 1100 Turbo	5639-845
'12-'13 M 800, M 800 HCR, M 1100, M 1100 Turbo, M 1100 Turbo HCR, XF 800 HC, XF 1100 Turbo HC	5639-846



Page 129

HAND MIRROR

Description	p/n
Hand Mirror	4992-810



A-ARM DEFLECTORS

Description	p/n
'12-'14 F5, F570; '07-'11 F Series; '08-'14 T570, TZ1 Touring; '09-'14 BC 570; '09-'11 Z1	4639-897



TOE HOLD

Sold in pairs.

Application
'10-'14 Sno Pro 500

p/n
5639-611



RECOIL HANDLE

Application

Black
Green
Orange

p/n
0636-363
3639-866
3639-867

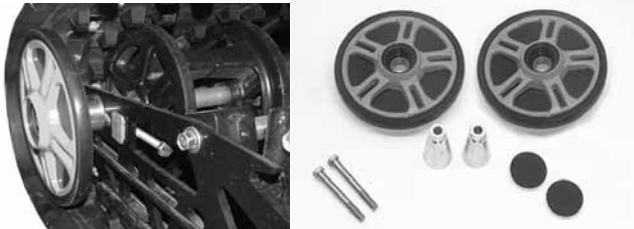

REAR WHEEL KIT

Adds two idler wheels to the outside of the rail. Includes wheels, spacer blocks and hardware. Recommended when adding studs to the models listed.

Application

'14 ZR LXR, SP; '12-'13 F LXR, SP

7.12" Wheel

Black
Team Arctic Green
Orange
White

p/n
6639-617
6639-618
6639-619
6639-620

'14 XF 137", XF CC, CT, HC 141"; '12-'14 M 153-162"; '12-'13 XF 141"

8.0" Wheel

Black
Team Arctic Green
Orange
White

6639-621
6639-622
6639-623
6639-624



WHEELS (IDLER WHEELS)

Includes bearing. Sold individually.

Description	p/n	Description	p/n
(A) 5.63" x .787" ID		(A) 7.12" x .787" ID	
Black	3604-386	Black	3604-063
Green	3604-047	Team Arctic Green	3604-969
Orange	3604-048	Pearl Cat Green	3604-066
Pink	3604-379	Orange	3604-065
Red	3604-044	Pink	3604-380
Silver	3604-043	Silver	3604-062
		White	3604-298
(A) 5.63" x .625" ID		(A) 7.12" x .625" ID	
Green	1604-691	Black	1604-683
Silver	1604-693	Green	1604-745
Yellow	2604-122	Silver	1604-971
(A) 6.38" x .625" ID		(B) 8.00" x .787" ID	
Green	1604-692	Black	3604-073
Orange	1604-765	Team Arctic Green	3604-972
Silver	1604-694	Pearl Cat Green	3604-075
		Orange	3604-191
(A) 6.38" x .787" ID		Red	3604-074
Black	3604-387	Silver	3604-076
Green	3604-053	White	3604-973
Orange	3604-054		
Red	3604-052	(C) 6.38" x .625" ID	
Silver	3604-055	Green	0604-980



SHORT SNOWFLAP

Application

'99-'06 121" Models
Models prior to '99

p/n
1606-507
0616-613

Mountain Accessories



Page 131

MOUNTAIN PACK

Application
 '14 XF 7000 CC, 8000 CC, 8000 HC, 9000 CC, 9000 HC, M 8000, 8000 HCR, 9000, 9000 HCR; '12-'13 M 800, 800 HCR, 1100, 1100T, 1100T HCR, XF 800 HC, 1100T HC; '09-'11 M Series, M8 HCR

p/n
 6639-401

Replacement Hardware

Strap w/Hook, Pk/4 0641-994
 Buckle Repair Kit, Pk/4 6639-545



Page 131

MOUNTAIN GEAR BAG

Application
 (A) '14 XF 7000 CC, 8000 CC, 8000 HC, 9000 CC, 9000 HC, M 8000, 8000 HCR, 9000, 9000 HCR; '12-'13 M 800, 800 HCR, 1100, 1100T, 1100T HCR, XF 800 HC, 1100T HC; '09-'11 M Series, M8 HCR

p/n
 6639-402

(B) '09-'11 M Series, M8 HCR 5639-044
 (C) '05-'08 M Series; '06-'08 CF 4639-727

Replacement Hardware

Strap w/Hook, Pk/4 (5639-044, 5639-711, 6639-402) 0641-994
 Cam Buckle, Pair (4639-727) 1639-248
 Tunnel Strap (See page 18) 6639-460



Page 131

TUNNEL PACK

Application
 (A) '14 ZR 5000, 6000, 7000, 8000, 9000, XF 7000, 7000 CC, 8000, 8000 CC, 8000 HC, 9000, 9000 CC, 9000 HC, M 8000, 8000 HCR, 9000, 9000 HCR; '12-'13 F 800, 1100, 1100T, XF 800, 800 HC, 1100, 1100T, 1100T HC, M 800, 800 HCR, 1100, 1100T, 1100T HCR

p/n
 6639-183

(B) '14 M 8000 Sno Pro, 8000 HCR w/o Electric Start 6639-574
 (C) '10-'14 Sno Pro 500; '10-'11 M Series 5639-433

Replacement Hardware

Spool w/Rivet, Pair (6639-183, 6639-574) 6639-154
 Front Clip, Pair (6639-183, 6639-574) 6639-155
 Strap w/Hook, Pk/4 (5639-433) 0641-994



Page 131

TUNNEL GEAR BAG

Application
 (A) '12-'14 F5, F570; '10-'11 F Series, M Series, Z1, Z1 Turbo, Z1 Turbo EXT; '11 F8 EXT 5639-574
 (B) '09-'11 M Series, CF, CFR, M8 HCR 5639-043

Replacement Hardware

Strap w/Hook, Pk/4 (5639-043, 5639-574) 0641-994
 Cam Buckle, Pair (5639-574) 0639-089



Page 131

HANDLEBAR BAG

Application
 '14 XF 7000 CC, 7000 CT, 8000 CC, 8000 CT, 8000 HC, 9000 CC, 9000 CT, 9000 HC, M 8000, 8000 HCR, 9000, 9000 HCR; '12-'13 XF 800, 1100, 1100T, M 800, 800 HCR, 1100, 1100T, 1100T HCR; '13 XF 800 CT, 1100 CT, 1100T CT 6639-469



Page 132

TANK GRIPS

Application
 '14 ZR; '12-'14 M, XF; '12-'13 F All Models 5639-762



Page 132

TANK PADS

Sold in pairs.

Application	Color	p/n
(A) '14 ZR; '12-'14 M, XF; '12-'13 F All Models	Black	5639-764
	Green	6639-403
	Orange	5639-766
	White	5639-096
Plastic Rivets (6/pk)		5639-930
(B) '05-'11 M Series; '06-'11 CF; '09-'11 CFR, M8 HCR	Black	5639-050
	Green	5639-051
	Orange	5639-052
Replacement Mounting Screw '05-'07 (Std)		8017-427
Replacement Mounting Screw '08-'11 (Metric)		8475-512
(C) '10-'14 Sno Pro 500	Black	5639-612

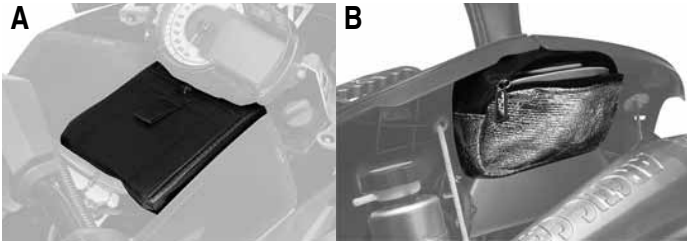

Page 132

GOGGLE HOLDER

CAUTION: Do not leave goggles in holder for an extended period of time. Excessive heat may damage goggles.

Application	p/n
(A) '14 ZR; '12-'14 M, XF; '12-'13 F All Models	5639-767
(B) '05-'11 M Series; '06-'11 CF; '09-'11 CFR, M8 HCR	4639-732
Replacement Hardware	
Latch Repair Kit (5639-767)	6639-076



Page 133

FUEL TANK

Application	p/n
12 Gallon - Long	
'12-'13 F 800, XF 800, XF 800 HC, M 800, M 800 HCR	6639-416
11.5 Gallon - Short	
'14 ZR 8000, M 8000 (Std), XF 8000, 8000 CC, 8000 HC; '12-'13 F 800, XF 800, 800 HC, M 800, 800 HCR w/o Battery	6639-417

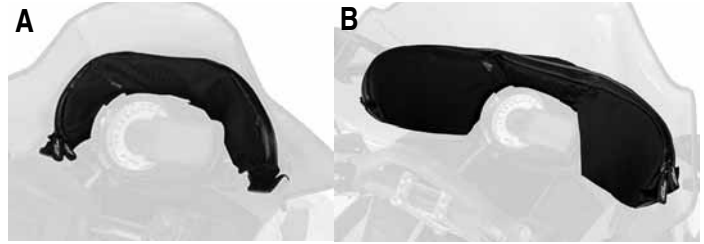

Page 132

WINDSHIELD BAG

Small bag (A) fits all windshields. Large bag (B) fits Accessory mid and high windshields.

Application	p/n
(A) '14 ZR 5000, 6000, 8000, 9000, XF 8000, 8000 CC, 8000 CT, 8000 HC, 9000, 9000 CC, 9000 CT, 9000 HC, M 8000, 8000 HCR, 9000, 9000 HCR; '12-'13 F 800, 1100, 1100T, XF 800, 800 HC, 1100, 1100T, 1100T HC, M 800, 800 HCR, 1100, 1100T, 1100T HCR; '13 XF 800 CT, 1100 CT, 1100T CT	5639-712
(A) '14 ZR 7000, XF 7000, 7000 CC, 7000 CT	6639-278
(B) '14 ZR 5000, 6000, 8000, 9000, XF 8000, 8000 CC, 8000 CT, 8000 HC, 9000, 9000 CC, 9000 CT, 9000 HC, M 8000, 8000 HCR, 9000, 9000 HCR; '12-'13 F 800, 1100, 1100T, XF 800, 800 HC, 1100, 1100T, 1100T HC, M 800, 800 HCR, 1100, 1100T, 1100T HCR; '13 XF 800 CT, 1100 CT, 1100T CT	6639-051
(B) '14 ZR 7000, XF 7000, 7000 CC, 7000 CT	6639-279
(C) '05-'11 M Series; '06-'11 CF; '09-'11 CFR, M8 HCR	4639-428

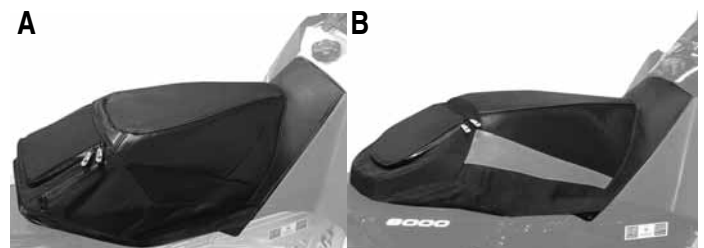

Page 133

PROCLIMB SEAT

Application	Color	p/n
Fits 12 Gallon Long Tank w/o Battery		
(A) '14 ZR 8000, M 8000 (Std), XF 8000, 8000 CC, 8000 HC; '12-'13 F 800, XF 800, 800 HC, M 800, 800 HCR	Black	6639-410
	Green	6639-411
	Orange	6639-412
Fits 11.5 Gallon Short Tank		
(B) '14 M 8000, 8000 SP, 8000 HCR w/o Electric Start	Black	6639-413
	Green	6639-414
	Orange	6639-415



Page 133

MOUNTAIN SEAT

Application	Color	p/n
'05-'09 M Series; '06-'11 CF; '09-'11 CFR	Black	5639-600
	Green	5639-601
	Orange	5639-602

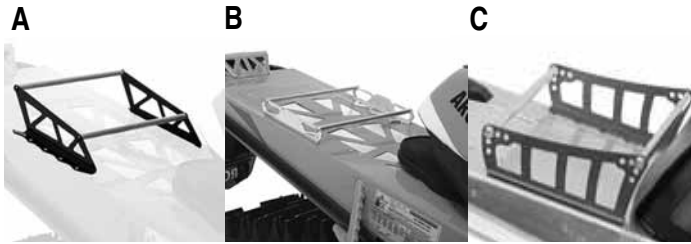

Page 133

A. PROCLIMB RACK

8" x 11 1/2" w

Application

'14 ZR; '12-'14 M, XF; '13 F w/Flat Tunnel

Color

p/n

Black	6639-159
Green	6639-297
Orange	5639-774
Silver	5639-775

B. BILLET RACK

8" x 13" w

Application

'14 ZR; '12-'14 M, XF; '13 F w/Flat Tunnel

Color

p/n

Black	5639-597
Silver	5639-598

C. M SERIES RACK

8 3/4" x 15" w

Application

'09-'11 M Series, M8 HCR

Color

p/n

Green	4639-975
Orange	4639-976
Unpainted	4639-977



Page 133

RACK STRAP

Application

'14 ZR; '12-'14 M, XF; '13 F w/Flat Tunnel; '09-'11 M Series, M8 HCR

p/n

4639-978



Page 134

FLOAT THROTTLE AVALANCHE AIRBAG

For technical assistance, contact BCA at 303-417-1345, ext. 0. Includes pressurized air cylinder, requires hazardous material shipping.

Description

Float Throttle

p/n

6639-107

BCA online resources

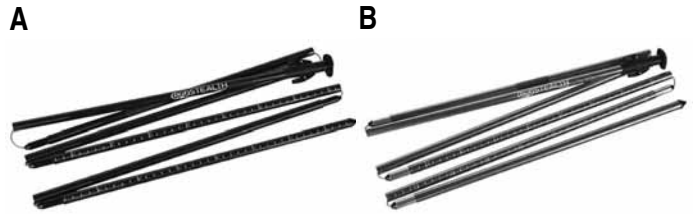

Page 134

AVALANCHE PROBES

Application

(A) BCA Carbon 260
(B) BCA Stealth 270

p/n

6639-409
6639-444

BCA online resources



Page 134

AVALANCHE BEACON

For technical assistance contact: BCA at 303-417-1345, ext. 0.

Description

BCA Tracker2 (457 kHz)

p/n

5639-610

BCA online resources



Page 134

BACKCOUNTRY PRO KIT

Description

Includes Ogjo Cornice backpack, BCA Tracker2 Beacon, Dozer Shovel and Stealth 270 Probe

p/n

6639-443



Page 134

BACKCOUNTRY KIT

Description
Includes BCA Stash Backpack, B-1 EXT Shovel and Stealth 270 Probe

p/n
6639-407



Page 135

BCA STASH

Application
2.2 lbs., 16 Liter capacity

p/n
6639-408



Page 134

POCKET SAW

Application
Saw with Pouch

p/n
4639-979



Page 135

HYDRATION PACK

Application
1 lb.

p/n
6639-446



Page 135

OGIO CORNICE

Application
3.3 lbs., 37 Liter capacity

p/n
6639-445



Page 135

TOOL PACK

Application
1.4 lb.

p/n
5242-905

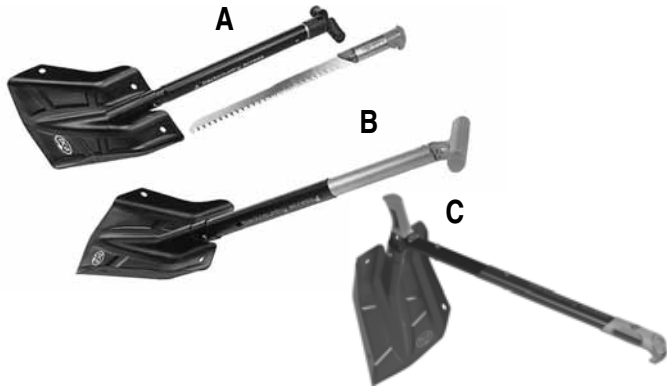

Page 135

SNOW SHOVELS

Description

- (A) BCA A-2 EXT with Saw (Extendable handle)
 (B) BCA B-1 EXT (Extendable handle)
 (C) BCA Dozer (Converts to Shovel or Hoe)

BCA online resources

p/n

5639-786
 5639-770
 6639-108

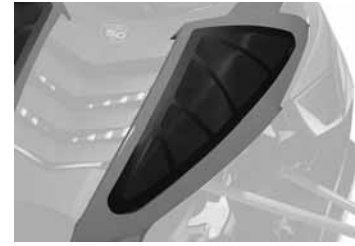

Page 137

VENTED HOOD PANELS

Description

'14 ZR; '12-'14 M, XF; '12-'13 F All Models

Hood Panel Kit with Screens (Pair)

Black	5639-862
Green	5639-863
Orange	5639-864
White	5639-991

Screen Set Only (Pair)

Hood Screens	5639-948
--------------	----------

Replacement Screens (Each)

Hood Screen - RH	6606-468
Hood Screen - LH	6606-469

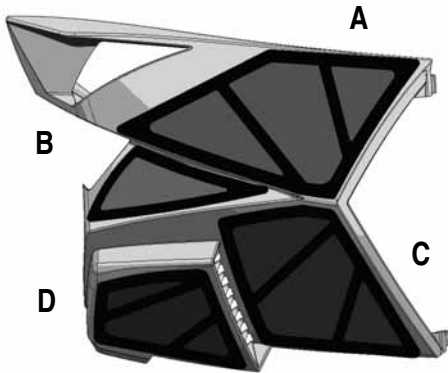

Page 137

VENTED SIDE PANELS

Description

'14 ZR; '12-'14 M, XF; '12-'13 F All Models

Side Panel Kit with Screens (Pair)

Black	5639-865
Green	5639-866
White	6639-084

Screen Set Only (Set of 7)

Side Panel Screens	5639-949
--------------------	----------

Replacement Screens (Each)

(A) Upper - RH	6606-470
(A) Upper - LH	6606-471
(B) Mid - LH	6606-485
(C) Lower, Rear - RH	6606-474
(C) Lower, Rear - LH	6606-475
(D) Lower, Front - RH	6606-472
(D) Lower, Front - LH	6606-473



Page 137

ICE SCRATCHERS

■Note: Ice Scratchers can be used on most Arctic Cat models. They must be mounted in a location that will not contact idler wheels or suspension arms. Mounting holes may need to be drilled in the rails.

Application

'14 XF 7000 CC, 8000 CC, 8000 HC, 9000 CC, 9000 HC, M 8000, 8000 HCR, 9000, 9000 HCR; '12-'13 M 800, 800 HCR, 1100, 1100T, 1100T HCR, XF 800, 800 HC, 1100, 1100T, 1100T HC; '05-'11 M Series; '06-'11 CF

Replacement Components

Wire - RH	1704-734
Wire - LH	1704-735
Mounting Hardware (Pair)	5639-941



Page 137

RAIL CAP WHEEL KIT

Application

'14 XF 7000 CC, 8000 CC, 8000 HC, 9000 CC, 9000 HC, M 8000, 8000 HCR, 9000, 9000 HCR; '12-'13 M 800, 800 HCR, 1100, 1100T, 1100T HCR, XF 800, 800 HC, 1100, 1100T, 1100T HC; '08-'11 M Series; '09-'11 CF

p/n

6639-213



Page 137

SWITCH GUARDS

Application	p/n
'14 ZR; '12-'14 M, XF; '12-'13 F All Models	5639-580

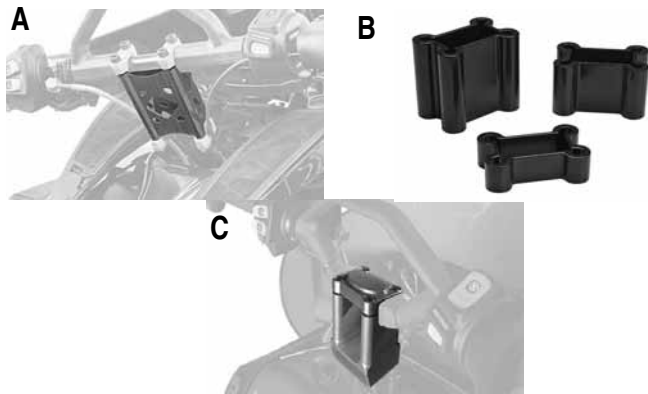

Page 138

A. HANDLEBAR RISERS

Application	p/n
'14 ZR; '12-'14 M, XF; '12-'13 F w/Fixed Steering Post	
2.0" - Unpainted	1605-086
3.0" - Unpainted	1605-063
3.5" - Unpainted	1605-112
4.5" - Unpainted	1605-035
5.5" - Unpainted	1605-073
6.5" - Unpainted	1605-034
7.5" - Unpainted	1605-070
2.0" - Black	6639-421
3.5" - Black	6639-422
4.5" - Black	5639-881
5.5" - Black	5639-882
6.5" - Black	5639-883
7.5" - Black	5639-884
8.5" - Black	5639-885
2.0" - Green	6639-423
3.5" - Green	6639-424
4.5" - Green	5639-886
5.5" - Green	5639-887
6.5" - Green	5639-888
7.5" - Green	5639-889
8.5" - Green	5639-890

B. HANDLEBAR RISERS

Application	p/n
'05-'11 M Series (Std); '06-'11 CF (Std)	
1" - Black	5639-776
2" - Black	5639-777
3" - Black	5639-778

C. ANGLED HANDLEBAR RISER

Application	p/n
'05-'11 M Series (Std); '06-'11 CF (Std)	
2" - Silver	5639-503
3" - Silver	5639-504



OFFSET RISER

Application	Color	p/n
'09-'11 M Series; M8 HCR w/Telescopic Post	Black	5639-595
	Silver	5639-596



Page 138

VERTICAL STEERING POST KIT

Application	p/n
'14 ZR 5000, 9000, XF 9000, M 9000 (Std); '13 M 1100 (Std), 1100T (Std); '12-'13 F 1100, 1100T, XF 1100, 1100T; '12 M 1100, 1100T, 1100T HCR	5639-945

■NOTE: Maximum riser height is 3.5"



Page 138

TELESCOPIC STEERING POST

■NOTE: Not available for CF5 - insufficient cable length.

Application	p/n
'14 M 8000 HCR	6639-418
'14 ZR 8000, XF 8000, M 8000 (Std); '12-'13 F 800, XF 800, M 800 (Std)	5639-813
'09-'11 M Series (Std), CF (Std)	5639-516



Page 138

HCR FIXED POST

Application	p/n
'14 M 8000 SP, XF 8000 HC; '12-'13 M 800 SP, 800 HCR, XF 800 HC (Models w/Telescopic Steering Post)	6639-419
'14 ZR 8000, XF 8000, M 8000 (Std); '12-'13 F 800, XF 800, M 800 (Std) (Models w/Lay Down Steering Post)	6639-420



Page 139

MOUNTAIN SPINDLES

Application	Color	p/n
'12-'13 M 800, 800 HCR, 1100, 1100T, 1100T HCR, XF 800 HC, 1100T HC	Black	6639-431
	Green	6639-432
	Orange	6639-433
	White	6639-434

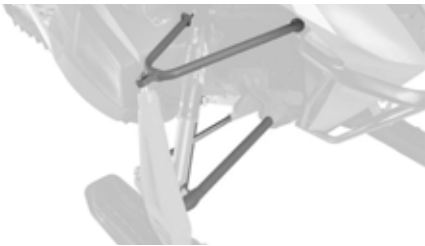

Page 139

NARROW A-ARM KIT - 38"

Application	Color	p/n
'12 M 800 (Std), M 800 SP, M 1100 (Std), M 1100 SP, M 1100 Turbo (Std), M 1100 Turbo SP, M 1100 Turbo HCR	Black	5639-938
	Green	5639-939
	White	5639-940



Page 139

SNOBUNJE PULLING TOOLS

Description	p/n
(A) Rattler (32" Long, 1.5 lbs)	5639-639
(B) Cobra (52" Long, 2.5 lbs)	5639-640
(C) Adapter Strap (60" Long)	5639-642
(D) Slicktape 20 (20' Long)	5639-643
(E) Cobra Adapter Strap (15" Long)	5639-641



PULL STRAP

Description	p/n
Pull Strap	5639-512



HI-TEMP CAM ROLLER

Set of 6.

Application	p/n
ACT Driven Pulley	5639-990



LIGHTWEIGHT FRONT AXLE KIT

Application
'05-'08 M Series

p/n
4639-995



2.5 GALLON FUEL CAN

Description
Scepter 2.5 gallon

p/n
1436-952



MOUNTAIN STRAP

Application
'10-'11 Z1 Turbo EXT; '11 F8 EXT

p/n
5639-358

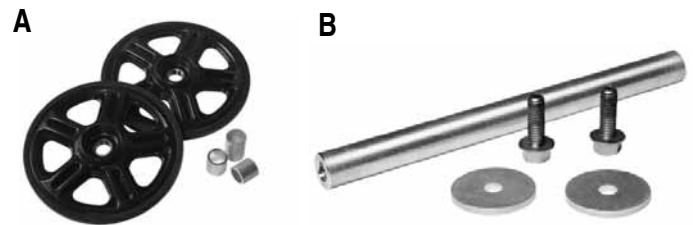

A. FOUR WHEEL KIT

Adds two inside wheels.

Application
'09-'11 M Series

p/n
5639-528

B. TWO WHEEL KIT

Application

p/n

Utility



Page 140

TUNNEL PACK

Application

'09-'14 BC 570 XT, BC Z1 XT; '14 BC 570 XTE

Replacement Hardware

Strap w/hook Pk/4

p/n

6606-252

0641-994



Page 140

BEARCAT GEAR BAG

Application

'09-'14 BC 570 XT, BC Z1 XT; '14 BC 570 XTE

p/n

5639-049



Page 140

THIRD SEAT

Application

'09-'14 BC 570 XT, BC Z1 XT; '14 BC 570 XTE

p/n

5639-063

A



B



Page 141

SIDE RAILS

Application

'09-'14 BC 570 XT, BC Z1 XT; '14 BC 570 XTE

(A) Short

(B) Long

p/n

5639-060

5639-061

Replacement Strap, ea (5639-060)

0641-993



Page 141

CARGO RACK

Application

'09-'14 BC 570 XT, BC Z1 XT; '14 BC 570 XTE

p/n

5639-062



Page 141

LOW RATIO GEAR SET

Includes input gear and fully assembled planetary ring gear assembly.

Application

'12-'13 BC Z1 XT GS; '09-'14 BC Z1 XT

p/n

6639-190

■NOTE: For more information on the Gear Exchange Program, see page 1.



Page 141

BACKUP LIGHT KIT

Application	p/n
'09-'14 BC Z1 XT	5639-389



Page 142

TRANSPORT MOUNT

Application	p/n
'09-'14 BC 570 XT, BC Z1 XT; '14 BC 570 XTE	5639-457

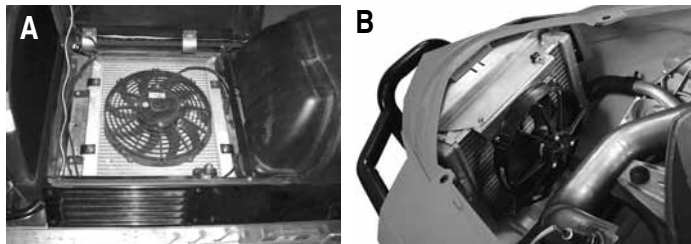

RADIATOR KIT

Includes radiator with electric cooling fan, hoses, and wiring.

Application	p/n
(A) '09-'14 BC Z1 XT (Under Seat)	4639-967
(B) '09-'14 BC Z1 XT (Front)	6639-180



Page 142

REAR HARNESS

Application	p/n
'09-'14 BC 570 XT, BC Z1 XT; '12-'14 BC Z1 XT GS; '14 BC 570 XTE	5639-456

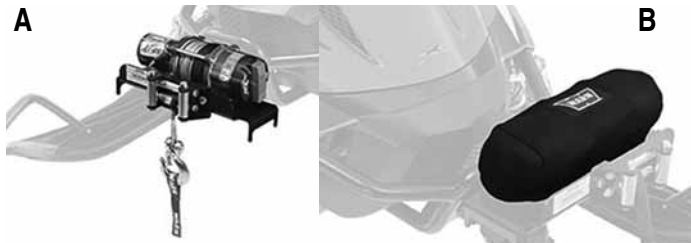

Page 142

RECEIVER WINCH

Application	p/n
(A) '09-'14 BC 570 XT, BC Z1 XT; '14 BC 570 XTE	5639-340
(B) Winch Cover	5639-459

Replacement Components	
Fairlead, Roller	0441-403
Mounting Pin	1441-142
Mounting Pin Clip	1441-143
Mounting Plate 2" Receiver	0641-256
Solenoid	0409-080
Switch, Handlebar	0641-249



Page 142

WARN PORTABLE WINCH KIT

Application	p/n
Models With Standard Battery	6639-073

Replacement Components	
Switch Assembly w/Harness	1641-009
Power Lead, Battery	1641-010
Power Lead, Extension	1641-011
Hook Strap	1641-012



Page 142

WINCH STOW PLATE

Description	p/n
Portable Winch (6639-073)	6639-074
Replacement Pin	1641-013



Page 143

CARGO SLEDS

Additional shipping charges may apply.

Description

74" L X 38" W X 17" D, 48 lb, Capacity - 600 lb

p/n

4639-126



Page 143

CARGO SLED COVER

Attaches with elastic cord.

Application

Cargo Sled (4639-126)

p/n

4639-129



Page 143

CARGO SLED RUNNER KIT

Application

Cargo Sled (4639-126) 6 Wearstrips

p/n

4639-131

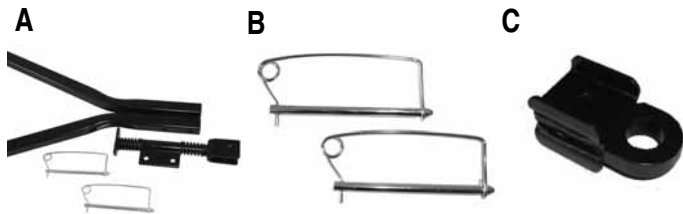

REPLACEMENT HARDWARE

Description

(A) Replacement Hitch
 (B) Replacement Pins (Pair)
 (C) Pintle Hitch Adapter

p/n

4639-941

5639-236

5639-463



Page 143

TRAIL GROOMER

Bearcat Z1 XT GS models have a standard radiator, groomer switches and outlet factory installed. All other '09-'14 Bearcat Z1 XT models require a Radiator Kit (page 46) and Groomer Harness Kit when pulling a Trail Groomer.

Description

Trail Groomer w/Mounting Plate & Ball
 Groomer Harness Kit*

Application

'12-'14 BC Z1 XT GS
 '09-'14 BC Z1 XT

p/n

5639-891
 5639-876

Replacement Components

Hitch Plate w/Ball
 Lift Actuator

5639-931
 5639-932

*Includes dash-mounted control switches, wiring harness, and rear outlet

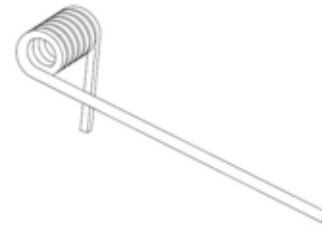

BEARCAT HD SPRINGS

Recommended when hauling heavy loads or pulling Trail Groomer.

Application

'09-'14 BC 570 XT, BC Z1 XT; '12-'14 BC Z1 XT GS; '14 BC 570 XTE

p/n

Spring, RH

2704-556

Spring, LH

2704-557

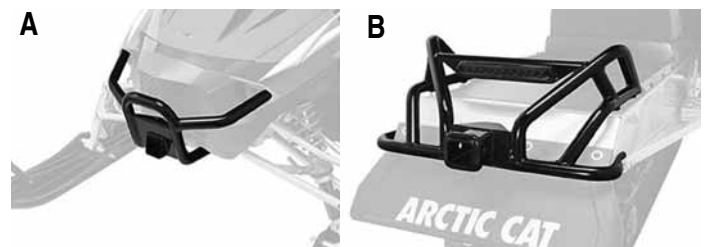

Page 144

RECEIVER BUMPER

Application

'09-'14 BC 570 XT, BC Z1 XT; '12-'14 BC Z1 XT GS; '14 BC 570 XTE

p/n

(A) Front

5639-338

(B) Rear

5639-339

Replacement Hitch Cover

0641-248



Page 144

SNOW PLOW PUSH FRAME

Requires Front Receiver Bumper and Receiver Winch.

Application	p/n
'09-'14 BC 570 XT, BC Z1 XT; '12-'14 BC Z1 XT GS; '14 BC 570 XTE	5639-341

Replacement Components

Eyebolt	0441-332
Mounting Pin	1441-977
Mounting Pin Clip	1441-143
Spring - Kickover	0741-009



Page 144

SNOW PLOW BLADE

60" Blade.

Application	p/n
Fits Snowplow Push Frame (5639-341)	0436-296

Optional Accessories

Edge Marker Kit	0436-235
Side Plate Kit	0436-232
Snow Deflector	0436-299

Replacement Components

Skid	0441-341
Wearbar	0441-447



Page 144

SKI SKINS

Fits 8" Saddleless Skis. 12" wide. Sold in pairs.

Application	p/n
'09-'14 BC 570, BC 570 XT, BC Z1 XT; '12-'14 BC Z1 XT GS; '14 BC 570 XTE	5639-254



Page 144

A. PIVOT HITCH

Application	p/n
'09-'14 BC 570 XT, BC Z1 XT; '12-'14 BC Z1 XT GS; '06-'07 BC WT; '07 BC 570	5639-387

B. HITCH

Pintle hitch not included. Accepts Pintle Hitch (p/n 4606-156)

Application	p/n
Receiver Bumper (p/n 5639-339)	5639-386



Page 144

PASSENGER HAND WARMERS

■NOTE: Not available for fan-cooled models - power output insufficient.

Application	p/n
(A) '09-'14 BC Z1 XT; '11-'12 BC Z1 XT Ltd	4639-970
(B) '08-'09 T500	4639-802



RACK MAT

Application	p/n
'09-'14 BC 570 XT, BC Z1 XT; '14 BC 570 XTE	5606-368

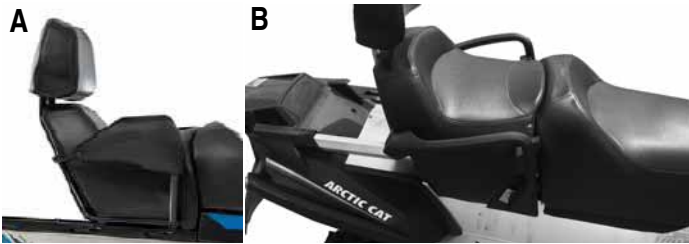

PASSENGER SEAT KIT

Includes seat assembly with backrest.

*Requires four mounting pins (0541-447).

Application

(A) '12-'14 BC Z1 XT GS*
(B) '09-'10 BC 570

p/n

4706-652
5639-201



OVERLOAD SPRING KIT

Application

'09-'10 BC 570
'14 BC 570 XTE

p/n

5639-106
6639-627

Tracks



Page 147

TRACKS - 2007-CURRENT APPLICATIONS

Tracks listed are required for use on 2007 and newer models with ACT drive and reverse but will also fit older models. All tracks listed feature an "All Open" window configuration with 2-ply construction unless noted. Pitch is measured at center of rods.

PERFORMANCE (2.52 P)

p/n	Dimensions (Studs)	Style	Duro	Weight	Clips
*1602-976	15" x 121" x 1.00"	Hacksaw	80/70	33	Every 3rd
*2602-268	15" x 121" x 1.352"	Cobra (Single-Ply)***	80	32	Every Other
*2602-002	15" x 121" x 1.25"	Ripsaw	80/70	36	Every 3rd
*2602-047	14" x 128" x 1.00"	Hacksaw	80/70	34	Every 3rd
*2602-019	15" x 128" x 1.00"	Hacksaw	80/70	36	Every 3rd
*2602-162	15" x 128" x 1.352"	Cobra***	80	37	Every Other
*2602-255	15" x 128" x 1.352"	Cobra (Single-Ply)***	80	34	Every 3rd
*2602-046	15" x 128" x 1.25"	Ripsaw	80/70	41	Every 3rd
*2602-835	15" x 128" x 1.50"	Ripsaw	80/70	42	Every 3rd
*1602-997	15" x 136" x 1.25"	Ripsaw	80/70	42	Every 3rd
*2602-005	15" x 136" x 1.50"	Ripsaw	80/70	42	Every 3rd

PERFORMANCE (2.86 P)

*2602-575	15" x 129" x 1.00"	Ripsaw II	80/70	34	Every Other
2602-503	15" x 129" x 1.00"	Ripsaw II	80/70	34	Every Other
*2602-576	15" x 129" x 1.25"	Ripsaw	80/70	40	Every Other
2602-474	15" x 129" x 1.25"	Ripsaw	80/70	40	Every Other
2602-490	15" x 129" x 1.25"	Ripsaw II	80/70	40	Every Other
*2602-577	15" x 129" x 1.352"	Cobra***	80/70	36	Every Other
2602-491	15" x 129" x 1.352"	Cobra***	80/70	36	Every Other
2602-485	15" x 129" x 1.70"	Sno Pro	80/70	42	Every Other
*2602-627	15" x 137" x 1.25"	Ripsaw II	80/70	42	Every Other
2602-670	15" x 137" x 1.352"	Cobra	80/70	40	Every Other
*2602-628	15" x 137" x 1.50"	Ripsaw	80/70	44	Every Other
2602-669	15" x 137" x 1.75"	Backcountry X	80/70	45	Every Other

TOURING (2.52 P)

2602-528	15" x 136" x 1.00"	Hacksaw	80/70	37	Every 3rd
*2602-101	15" x 144" x 1.00"	Hacksaw	80/70	40	Every 3rd
*2602-163	15" x 144" x 1.352"	Cobra	80	41	Every Other
*2602-350	15" x 144" x 1.50"	Crossover (Single-Ply)	80	47	Every 3rd

MOUNTAIN TRACKS (3.0 P)

2602-169	15" x 141" x 1.352"	Cobra (Single-Ply)***	80	38	Every Other
2602-170	15" x 141" x 1.60"	Cobra (Single-Ply)	80	40	Every Other
2602-166	15" x 141" x 2.25"	Power Claw (Single-Ply)	80	44	Every Other
2602-167	15" x 153" x 2.25"	Power Claw (Single-Ply)	80	48	Every Other
2602-399	15" x 153" x 2.25"	Power Claw (Single-Ply)	85	48	Every Other
2602-481	15" x 153" x 2.60"	Power Claw (Single-Ply)	80	50	Every Other
2602-482	15" x 153" x 2.60"	Power Claw (Single-Ply)	85	50	Every Other
2602-168	15" x 162" x 2.25"	Power Claw (Single-Ply)	80	50	Every Other
2602-367	15" x 162" x 2.25"	Power Claw (Single-Ply) (Notched)	80	48	Every Other
2602-438	15" x 162" x 2.25"	Power Claw (Single-Ply)	85	50	Every Other
2602-483	15" x 162" x 2.60"	Power Claw (Single-Ply)	80	52	Every Other
2602-484	15" x 162" x 2.60"	Power Claw (Single-Ply)	85	52	Every Other

UTILITY (2.52 P)

2602-314	15" x 151" x 1.25"	Ripsaw (Single-Ply)	80	45	Every 3rd
0602-962	20" x 156" x 1.00"		60	63	Fully Clipped
1602-869	20" x 156" x 1.25"		80	67	Fully Clipped

UTILITY (2.86 P)

2602-358	20" x 154" x 1.375"	(Single-Ply)	80/70	58	Every 3rd
2602-639	20" x 154" x 1.375"	Utility (Single-Ply)	80/70	58	Every 3rd
2602-640	20" x 154" x 1.50"	Cobra	80/70	62	Every Other

ICE TECH SERIES (2.52 P)**

*2602-032	15" x 121" x 1.25"	ICE Ripper (258) (Single-Ply)	70	38	Every 3rd
2602-376	15" x 128" x 1.25"	ICE Ripper (272) (Single-Ply)	70	42	Every 3rd

ICE TECH SERIES (2.86 P)**

2602-598	15" x 129" x 1.25"	ICE Ripper (240)	80/70	42	Every Other
2602-672	15" x 137" x 1.22"	ICE Attack XT (256) (Single-Ply)	70	42	Every Other

* ACT Quiet Tracks are for use on '03 and newer models only.

**To protect the tunnel from possible stud damage, a Tunnel Protector Kit (page 58) should be installed on models not equipped

***Cobra 1.352" tracks have a standard lug height of 1.25". The overall lug height including the extended "towers" is 1.352".

2014 TRACK APPLICATION

Model	Year	Single-Ply	2-Ply
Bearcat 570	'10-'14	2602-314	
BC 570 XT, Z1 XT, Z1 XT GS	'14	2602-639	
F570	'14		2602-096
F5	'14		2602-019
SP 500	'14		2602-162
T570, TZ1 Touring	'09-'14		2602-101
TZ1 Turbo Touring	'09-'13		2602-163
XF 7000, 8000, 9000 LXR, SP (137")	'14		2602-627
XF 7000, 8000, 9000 CC (141")	'14	2602-170	
XF 7000, 8000, 9000 CT	'14	2602-169	
XF 8000, 9000 HC	'14	2602-166	
ZR 5000 LXR	'14		2602-575
ZR 6000, 7000, 8000, 9000 LXR, SP	'14		2602-576
ZR 8000, 9000 SP RR	'14		2602-576

■NOTE: For more information on the Arctic Cat Track Exchange Program, see page 1.

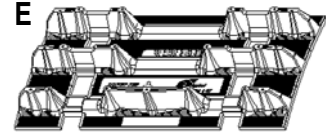
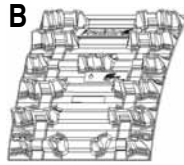
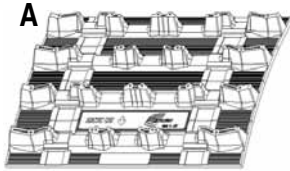

TRACKS - 2006-PRIOR APPLICATIONS

Tracks listed below will not fit 2007 and newer models with ACT drive and reverse.

15" TRACKS (2.52 P)

p/n	Dimensions	Style	Duro	Weight	Clips	Windows
*1602-756	121" x .850"	A	60	34	Every 3rd	Every 3rd Closed
2602-398	121" x 1.00"	Hacksaw NQ	80/70	33	Every 3rd	All Open
*1602-504	121" x 1.00"	B	80/60	34	Every 3rd	Every 3rd Closed
2602-396	121" x 1.25"	Ripsaw NQ	80/70	36	Every 3rd	All Open
2602-397	121" x 1.352"	Cobra NQ (Single-Ply)	80	32	Every Other	All Open
*1602-506	121" x 1.375"	E	80/60	40	Fully Clipped	All Open
2602-096	128" x 1.00"	Challenger LP	80		Every 3rd	All Open
2602-147	128.5" x 1.70"		80		Every Other	All Open
2602-100	144" x 1.00"	Challenger LP	80		Every 3rd	All Open
1602-137	144" x 2.00"	Challenger (Notched)	80/60	46	Fully Clipped	All Open
2602-517	156" x 1.00"	Utility	80		Every Other	All Open

13.5" TRACKS (2.52 P)

*1602-502	128" x 1.00"	E	80/60	33	Every 3rd	Every 3rd Closed
*1602-886	128" x 1.00"	Hacksaw	80/60	34	Every 3rd	Every 3rd Closed
*1602-503	128" x 1.375"	E	80/60	39	Fully Clipped	All Open
1602-657	128" x 1.70"		80		Every Other	All Open
1602-750	144" x 1.25"	A	80/60	34	Every 3rd	All Open

MISC. TRACKS

2602-476 120 (10" x .688")
0602-927 Kitty Cat

- Cobra 1.352" tracks have a standard lug height of 1.25". The overall lug height including the extended "towers" is 1.352".
- 60 Durometer is a softer compound and is preferred by deep powder riders.
- 80 and 90 Durometer is a harder compound to give greater penetration and are preferred hill climb tracks.
- 80/60, 80/70 Durometer are dual compound tracks with the lug tip 60 or 70 durometer and the remainder 80 durometer.
- Tracks w/o Notch fit '03-'04 MC models.
- 2.25" tracks fit '99-'04 MC models.
- Non-Quiet (NQ) Tracks can be used on competitive brands.

2009-2013 Track Application

Model	Year	Single-Ply	2-Ply
Bearcat 570	'09		2602-163
Bearcat 570 XT, Z1 XT	'11-'13	2602-358	
	'09-'10		1602-869
Bearcat Z1 XT GS	'12-'13		1602-869
Crossfire	'09-'11	2602-169	
Crossfire SP	'09-'11	2602-170	
CFR	'09-'11		2602-047
F 800 LXR, F 1100 LXR	'13		2602-575
F 1100 Turbo LXR	'13		2602-576
F 800 SP, F 1100 SP (Inc Turbo)	'13		2602-576
F 800 LXR, F 1100 LXR	'12		2602-019
F 1100 Turbo LXR	'12		2602-046
F 800, F 1100 Sno Pro (Inc Turbo)	'12		2602-046
F Series (Std), LXR	'09-'13		2602-019
F Series SP	'10-'11		2602-046
	'09	2602-255	
Sno Pro 500	'11-'13		2602-019
	'10	2602-255	
XF 800, 1100, 1100T LXR	'12-'13	2602-169	
XF 800, 1100, 1100T SP	'12-'13	2602-170	
XF 800, 1100T HC	'12-'13	2602-166	
XF 800, 1100, 1100T CT	'13	2602-169	
Z1 (Std), LXR	'09-'11		2602-019
Z1 Turbo (Std)	'09-'10		2602-019
Z1 Turbo LXR	'10-'11		2602-046
	'09	2602-255	
Z1 Turbo SP	'10-'11		2602-046
	'09	2602-255	

MAXIMUM LUG HEIGHT

Model	Year	Height
CF	'09-'11	2.25"
	'06-'08	2.00"
F	'12-'13	2.25"
F Series	'07-'11	1.50"
FC (ACT)	'05-'06	1.70"
JR	'07-'08	1.50"
M Series	'08-'11	2.60"
M	'12-'14	2.60"
T570, TZ1	'08-'14	1.25"
ZR	'14	2.25"
Z1	'09-'11	1.50"
XF	'12-'14	2.25"
136" Straight Tunnel Models		1.60"

■NOTE: When installing a 2.60" track on '12 M models, it is necessary to lower the skid frame which will require drilling the front mounting holes. A template is available on Cat Quest (Solution #K68201226). A larger Rail Cap (p/n 3604-836) or a Rail Cap Wheel Kit (6639-213) is recommended for '12-'13 M models when lowering the skid frame for a 2.60" track.

Wearbars

Ski Applications					
	A	B	C	D	E
Standard Wearbars	'05-'14 Saddleless '03-'06 FC, SC '02-'06 ZR	ZR-Style, Parabolic, Deep Snow, Universal Plastic Ski	Blow-Molded Plastic Ski	SLP Powder Pro	C&A Pro
7/16" Diameter Round Host Bar (Pair)	p/n	p/n	p/n	p/n	p/n
Hardweld Wearbar (No Carbide Inserts)	3639-309	0639-198	1639-744		
4" Carbide With Hardweld			1639-527		
6" Carbide With Hardweld			1639-528		
1/2" Diameter Round Host Bar (Pair)					
4" Carbide With Hardweld	3639-310	3639-978		3639-420	
6" Carbide With Hardweld	3639-311	1639-521		3639-421	5639-604
8" Carbide With Hardweld	3639-312	0639-378			5639-605
10" Carbide With Hardweld	3639-313				
5/8" Diameter Round Host Bar (Pair)					
8" Carbide With Hardweld	3639-314				
10" Carbide With Hardweld	3639-315				5639-606
10" Competition Carbide	3639-318				
Shaper Wearbars					
4.5" Carbide (Pair)	4639-949				
6" Carbide (Pair)	4639-950				
7.5" Carbide (Pair)					4639-952
9" Carbide (Pair)	4639-951				4639-953

■NOTE: The accessory Saddleless Ski wearbars listed use a 4-bolt stud pattern. When using accessory wearbars on Saddleless Skis with a 3-bolt stud pattern, it will be necessary to drill another mounting hole in the ski.

Dual Wearbars	'05-'14 Saddleless '03-'06 FC, SC '02-'06 ZR	ZR-Style, Para- bolic, Deep Snow, Universal
Dooly™ Twin Carbide Wearbars (Each)		
Hardweld Wearbar	5639-879	
4" Carbide With Hardweld	3639-343	3639-346
6" Carbide With Hardweld	3639-344	3639-347
8" Carbide With Hardweld	3639-345	3639-348
Deuce™ Twin Carbide Wearbars (Each)		
4.5" Carbide	5639-251	
6" Carbide	5639-252	
9" Carbide	5639-253	
Staggered Wearbars (Each)		
4" Carbide (RH) 3-Bolt (Standard)	2603-988	
4" Carbide (LH) 3-Bolt (Standard)	2603-989	
4" Carbide (RH) 4-Bolt (Aggressive)	2603-930	
4" Carbide (LH) 4-Bolt (Aggressive)	2603-931	
Steel Ski Wearbars	AFS (4-Bolt)	AWS (3-Bolt)
7/16" Diameter Round Host Bar (Pair)		
Hardweld Wearbar		1639-784
4" Carbide With Hardweld	0638-399	4639-013
6" Carbide With Hardweld	0638-520	

Bulk Pack Wearbars

Our most popular 4", 6", and 8" accessory carbide wearbars are available in bulk packaging, 10 pairs with nuts to a box. These are the same wearbars that we offer in Arctic Cat packaging. Bulk packaging allows Arctic Cat to offer you ultra-competitive pricing on these high volume wearbars.

Description

p/n

Wearbars For Arctic Cat '05-'14 Saddleless Skis; '03-'06 FC, SC; '02-'06 ZR

10 Pairs 3639-310 - 4" Carbide With Hardweld	2639-184
10 Pairs 3639-311 - 6" Carbide With Hardweld	2639-185
10 Pairs 3639-312 - 8" Carbide With Hardweld	2639-186

Wearbars for ZR Style, Parabolic, and Deep Snow Plastic Skis

10 Pairs 3639-978 - 4" Carbide With Hardweld	3639-979
10 Pairs 1639-521 - 6" Carbide With Hardweld	2639-189

Stud Quantity/Inches of Turning Carbide

Sled	Trail	Performance
50-75 HP	48/4 in.	48/6 in.
75-125 HP	102/6 in.	153/8 in.
125-150 HP	153/8 in.	153/10 in.
150-170 HP	153/8 in.	153/10 in.



STEEL SKI WEARBAR APPLICATIONS

Application	Year	4" Carbide With Hardweld p/n	6" Carbide With Hardweld p/n
AFS	'91 & older	0638-399	0638-520
BC 340	'95-'99	0638-399	0638-520
BC 440	'95-'98	0638-399	0638-520
BC 550	'95-'97	0638-399	0638-520
Cheetah Touring	'86-'91	0638-399	0638-520
	'92-'93	4639-013	
Cheetah	'94	4639-013	
Cougar	'86-'91	0638-399	0638-520
Cougar, Cougar MC	'92-'97	4639-013	
El Tigre	'86-'89	0638-399	0638-520
EXT, EXT MC	'89-'91	0638-399	0638-520
	'92-'97	4639-013	
EXT Special	'91	4639-013	
	'92	0638-399	0638-520
EXT MC	'94-'96	0638-399	0638-520
EXT 580 Z	'93	0638-399	0638-520
EXT 600	'97-'98	4639-013	
Jag, Jag Deluxe	'92-'97	4639-013	
Jag AFS	'89-'91	0638-399	0638-520
Jag AFS LT	'90-'91	0638-399	0638-520
Jag Special	'91	4639-013	
	'92	0638-399	0638-520
Jag Z	'93-'94	0638-399	0638-520
Lynx	'91	0638-399	0638-520
	'92-'93	4639-013	
PTA	'86-'90	0638-399	0638-520
	'91-'96	4639-013	
PA	'90-'91	0638-399	0638-520
	'92-'99	4639-013	
Prowler, Prowler MC	'90	0638-399	0638-520
	'91-'95	4639-013	
Prowler Special	'91	4639-013	
	'92	0638-399	0638-520
Puma, Deluxe, 2-Up	'94-'97	4639-013	
TC	'93-'96	4639-013	
TC MC	'94-'95	4639-013	
WC, WC MC	(AFS) '91-'92	4639-013	
	(AWS) '92-'94	0638-399	0638-520
	'95-'96	4639-013	
Z 440	'95-'96	0638-399	0638-520
ZR 440	'93-'94	0638-399	0638-520
ZR 580, 700 (Steel Ski)	'93-'96	0638-399	0638-520

4 Bolt Wearbar; 0638-399, 0638-520

3 Bolt Wearbar; 4639-013

HARDWELD WEARBARS

Application	Year	p/n
4-Stroke Trail	'02	1639-744
4-Stroke Touring	'02	1639-744
	'97-'01	0639-198
BC 340	'00	1639-744
	'95-'99	1639-784
BC 440	'99-'00	0639-198
	'97-'98	1639-784
BC 550	'98-'02	0639-198
Cheetah Touring	'92-'93	1639-784
Cheetah 340, 440, 550	'94	1639-784
Cougar, Cougar 2-Up	'92-'98	1639-784
Cougar Dlx	'98	0639-198
EXT	'91-'98	1639-784
EXT Dlx	'98	0639-198
EXT Special	'91	1639-784
EXT 600	'97-'98	1639-784
EXT 600 Touring	'98	0639-198
FC	'03	3639-309
Jag	'92-'99	1639-784
Jag AFS L/T	'92-'93	1639-784
Jag Liquid	'96	1639-784
Jag Special	'91	1639-784
Lynx	'92-'93	1639-784
MC	'01-'04	0639-198
PTA 550	'02-'03	1639-744
PTA 660	'02-'03	0639-198
PTA 800	'02	0639-198
PTA	'91-'01	0639-198
	'91-'96	1639-784
PA	'00-'05	1639-744
	'92-'99	1639-784
PE	'97-'98	0639-198
PS	'96-'00	0639-198
Prowler	'91-'95	1639-784
	'90	1639-784
Prowler Special	'91	1639-784
Puma	'94-'97	1639-784
TC	'97-'02	0639-198
	'93-'95	1639-784
WC	'95-'96	1639-784
	'91	1639-784
WC EFI (AFS)	'91-'92	1639-784
Z 370	'99-'05	1639-744
Z 440	'00-'02	1639-744
	'97-'99	0639-198
Z 570	'02-'05	1639-744
ZL	'97-'03	0639-198
ZR	'97-'01	0639-198
ZR 440	'96-'99	0639-198
ZRT	'96-'02	0639-198

Traction & Control

2014 TRACK LUG HEIGHTS AND RECOMMENDED STUD LENGTH

Model	Track Length/ Lugs	Woody's Stud Length	Stud Boy Stud Length	Model	Track Length/ Lugs	Woody's Stud Length	Stud Boy Stud Length
Single-Ply Tracks				2-Ply Tracks			
Bearcat 570	151" x 1.250"	1.325	1.375	F5, F570	128" x 1.000"	1.075	1.080
Bearcat 570 XT, Z1 XT	154" x 1.375"	1.450	1.500	SP 500	128" x 1.250"	*1.325	1.375
XF 7000, 8000, 9000 CT	141" x 1.352**	*1.325	*1.375	T570, TZ1, TZ1 LXR	144" x 1.000"	1.075	1.080
XF 7000, 8000, 9000 CC SP	141" x 1.600"	1.575	N/A	XF 7000, 8000, 9000	137" x 1.250"	1.325	1.375
				ZR 5000 LXR	129" x 1.000"	1.075	1.080
				ZR 6000	129" x 1.250"	1.325	1.375
				ZR 7000, 8000, 9000 LXR	129" x 1.250"	1.325	1.375
				ZR 7000, 8000, 9000 SP	129" x 1.250"	1.325	1.375
				ZR 8000, 9000 SP RR	129" x 1.250"	1.325	1.375

* Cobra 1.352" tracks have a standard lug height of 1.25". The overall lug height including the extended "towers" is 1.352". Because the "towers" will flex, Cobra 1.352" tracks use the same length studs as a 1.25" track.

CAUTION

- To protect the tunnel from possible damage from the studs, install a Tunnel Protector Kit (see page 58) on models not so equipped. Do not use longer than recommended studs. Use only Arctic Cat approved Stud Templates shown on page 57.
- For Stud Length 1.325" and longer, we recommend the use of a Big Nut or Power Tower Support Nut.
- A short snowflap is required when installing studs on '07-'09 F Series, JR, Z1, and '11 CF (see page 58).
- Do not stud the original 1.250" track on the '06-'08 BC WT Turbo. Damage to the heat exchangers may occur. If you wish to install studs on '06-'08 BC WT Turbo track, the original 1.250" track must be replaced with a 1.00" track.

Single-Ply Track Application

■NOTE: '09-'14 Track applications shown on page 49.

⚠ WARNING

When installing studs on a single-ply track, it is important to use Arctic Cat-approved studs (proper head diameter). If approved studs (proper head diameter) are not used, studs could tear free of the track causing possible injury or even death.

■NOTE: A Rear Wheel Kit is recommended when installing studs on '12-'13 F; '12-'14 XF; '14 ZR Models (See page 35).

■NOTE: '12-'13 XF Sno Pro models with 1.60" track require Tunnel Protector kit 6639-118 or 6639-179. The wear strips used in these kits have a taller profile for additional heat exchanger protection.

WOODY'S

A. Page 150

GRAND MASTER™ TRACTION KITS

60° Carbide Tip, 5/16" Thread, 1.20" Head.

Application	Qty	p/n
'14 XF 7000 CT, 8000 CT, 9000 CT; '13 XF 800 CT, 1100 CT, 1100T CT; '12-'13 XF 800 LXR, 1100 LXR, 1100T LXR 141" X 1.352" 3.0 P		
1.325" Studs	94/Pk	5639-144
'14 XF 7000 CC, 8000 CC, 9000 CC; '12-'13 XF 800 SP, 1100 SP, 1100T SP 141" X 1.60" 3.0 P		
1.575" Studs	94/Pk	6639-198
'11-'14 BC XT; '14 BC XT GS, BC 570 XTE 154" x 1.375"		
1.450" Studs	108/Pk	5639-626
'09 F Series SP Z1 Turbo LXR, Z1 Turbo SP; '10 SP 500 128" x 1.25"		
1.325" Studs	102/Pk	5639-230
1.325" Studs	153/Pk	5639-231

GRAND MASTER™ STUDS

60° Carbide Tip, 5/16" Thread, 1.20" Head.

Description	Qty	p/n
1.325" With Big Nut	500/Pk	5639-426
1.575" with Big Nut	500/Pk	6639-492

GRAND MASTER™ SUPPORT PLATES

Description	Qty	p/n
Single, Square 1.50"	500/Pk	5639-427
Double	51/Pk	5639-486

2-Ply Track Application



Page 150

TRACTION KITS

Includes Signature Series Studs, Support Plates, Standard or Big Nuts, Template, Drill, and Track Marker.

Application	Qty	p/n
'14 XF 7000 LXR, 7000 SP, 8000 LXR, 8000 SP, 9000 LXR, 9000 SP 137" x 1.25" 2.86 P		
1.325" Studs	96/Pk	6639-454
1.325" Studs	144/Pk	6639-455
'14 ZR 6000, 7000 LXR, 7000 SP, 8000 LXR, 8000 SP, 9000 LXR, 9000 SP; '13 F 800 SP, 1100 SP, 1100T LXR, 1100T SP 129" x 1.25" 2.86 P		
1.325" Studs	90/Pk	6639-133
1.325" Studs	135/Pk	6639-134
'14 ZR 5000 LXR; '13 F 800 LXR, 1100 LXR 129" x 1.00" 2.86 P		
1.075" Studs	90/Pk	6639-131
1.075" Studs	135/Pk	6639-132
'14 SP 500; '12 F 800 SP, 1100 SP, 1100T LXR, 1100T SP; '10-'11 F Series SP, Z1 Turbo LXR, Z1 Turbo SP 128" x 1.25" 2.52 P		
1.325" Studs	102/Pk	5639-781
1.325" Studs	153/Pk	5639-782
'12 F 800 LXR, 1100 LXR; '07-'11 F Series; '09-'11 CFR, Z1, Z1 Turbo; '11-'13 SP 500 128" x 1.00" 2.52 P		
1.075" Studs	102/Pk	4639-550
1.075" Studs	153/Pk	4639-551
'06-'08 CF 136" x 1.25"		
1.325" Studs	108/Pk	4639-340
1.325" Studs	162/Pk	4639-341
'11-'13 Sno Pro 600 SX 129" x 1.70" Track 2.86 P		
1.860" Studs	90/Pk	5639-637



B. Page 150

GOLD DIGGER® TRACTION MASTER®

60° Carbide Tip, 5/16" Threads, 1" Head. Support Plates sold separately.

Description	Qty	p/n
1.075 Stud With Nyloc Nut	90/Pk	6639-125
	96/Pk	6639-486
	102/Pk	3639-067
	135/Pk	6639-126
	144/Pk	6639-487
	153/Pk	4639-748
	1000/Pk	1639-118
1.175 Stud With Nyloc Nut	90/Pk	6639-127
	96/Pk	6639-488
	102/Pk	3639-069
	135/Pk	6639-128
	144/Pk	6639-489
	153/Pk	4639-749
	1000/Pk	1639-958
1.325 Stud With Big Nut	90/Pk	6639-129
	96/Pk	6639-490
	102/Pk	3639-362
	135/Pk	6639-130
	144/Pk	6639-491
	153/Pk	4639-750
	1000/Pk	1639-519
1.450 Stud With Big Nut	102/Pk	5639-913
	153/Pk	5639-914
	1000/Pk	5639-915

B



C



C. Page 150

SIGNATURE SERIES STAINLESS STEEL

60° Carbide Tip, 5/16" Threads, 15/16" Head. Support Plates sold separately.

Description	Qty	p/n
1.075 Stud With Nyloc Nut	90/Pk	6639-119
	96/Pk	6639-480
	102/Pk	3639-915
	135/Pk	6639-120
	144/Pk	6639-481
	153/Pk	4639-739
	1000/Pk	3639-917
1.175 Stud With Nyloc Nut	90/Pk	6639-121
	96/Pk	6639-482
	102/Pk	3639-919
	135/Pk	6639-122
	144/Pk	6639-483
	153/Pk	4639-740
	1000/Pk	3639-921
1.325 Stud With Big Nut	90/Pk	6639-123
	96/Pk	6639-484
	102/Pk	3639-923
	135/Pk	6639-124
	144/Pk	6639-485
	153/Pk	4639-741
	1000/Pk	3639-925
1.450 Stud With Big Nut	102/Pk	3639-927
	153/Pk	4639-742
	1000/Pk	3639-929



Page 151

DIGGER SUPPORT PLATES

Description	Color	Qty	p/n
1.250" Square	Unpainted	90/Pk	6639-164
		96/Pk	6639-497
		102/Pk	3639-093
		135/Pk	6639-165
		144/Pk	6639-498
		153/Pk	4639-752
1.250" Square	Black	1000/Pk	0639-907
		90/Pk	6639-168
		96/Pk	6639-501
		102/Pk	4639-257
		135/Pk	6639-169
		144/Pk	6639-502
1.250" Square	Green	153/Pk	4639-753
		1000/Pk	4639-259
		90/Pk	6639-170
		96/Pk	6639-503
		102/Pk	3639-388
		135/Pk	6639-171
1.250" Square	Orange	144/Pk	6639-504
		153/Pk	4639-754
		1000/Pk	2639-857
		90/Pk	6639-172
		96/Pk	6639-505
		102/Pk	3639-390
1.375" Round	Unpainted	135/Pk	6639-173
		144/Pk	6639-506
		153/Pk	4639-755
		1000/Pk	2639-861
		90/Pk	6639-166
		96/Pk	6639-499
1.375" Round	Black	102/Pk	3639-091
		135/Pk	6639-167
		144/Pk	6639-500
		153/Pk	4639-751
		1000/Pk	3639-005
		96/Pk	6639-553
1.375" Round	Green	102/Pk	6639-554
		135/Pk	6639-555
		144/Pk	6639-556
		153/Pk	6639-557
		1000/Pk	6639-558
		90/Pk	6639-559
1.375" Round	Orange	96/Pk	6639-560
		102/Pk	6639-561
		135/Pk	6639-562
		144/Pk	6639-563
		153/Pk	6639-564
		1000/Pk	6639-565
1.375" Round	Orange	90/Pk	6639-566
		96/Pk	6639-567
		102/Pk	6639-568
		135/Pk	6639-569
		144/Pk	6639-570
		153/Pk	6639-571
1000/Pk	6639-572		



Page 151

DOUBLE DIGGER™ SUPPORT PLATES

Description	Qty	p/n
5/16"	12/Pk	2639-134
	48/Pk	2639-135

Woody's Limited Warranty

International Engineering & Manufacturing, Inc. warrants each product manufactured by it to be free from defects in material and workmanship under use for the purpose for which it is intended. The Company shall not be liable for damage or delays caused by defective materials or workmanship; is limited to the repair or replacement at its factory of defective article or part thereof, which may be returned to the factory, transportation charges, prepaid within one (1) year after delivery to the original purchaser. Proof of purchase is also required. The Company shall be the sole judge of the existence of any defect in the article so returned. No claims for charges incurred in the removal, disassembly or reinstallation of such article shall be allowed. Product manufactured for consumer use on snowmobiles is designed for snow or ice only, use on any other surface voids warranty.

This Warranty shall not cover any article which has been misused or neglected or damaged by accident or any article which has been altered outside the Company's factory. The Warranty for studs is void unless the studs are installed with Woody's installation tools, support plates and lock nuts; according to the recommendations set forth in Woody's Instructions and Template Patterns. This Warranty does not cover bending, chipping, flaking or carbide pin breakage or pin loss from stud wear, stud replacement labor or shipping.

The Company shall, in no event be liable for consequential damage or contingent liability arising out of any total or partial failure to function of any article manufactured by it or of any equipment on or in which it is used. Failure of a user to give notice to claim as to defect claimed under the provisions of the Warranty within one (1) year after delivery to original use, such claim shall constitute a waiver by consumer of all claims with respect to goods and equipment.

No express, implied, or statutory warranty other than that herein set forth is made or authorized to be made by the Company. All returned warranties will not be accepted without a return authorization number.

Woody's® Team Woody's®, Snowmobiler Logo, Traction Master, Flat-Top, Gold Digger, Mega-Bite, Excel, Chisel Tooth, Square Digger, Round Digger, Double Digger, Road Runner, Star Stud, Top-Stock, Extender Trail III, Trail Blazer IV, Executive, and Ultra Series are trademarks and/or trade names of International Engineering and Manufacturing, Inc. Traction Master refers to a patented product of International Engineering & Manufacturing, Inc. and is covered by US Patent No. 5,23,266 and Canadian Patent No. 2,086,186. Woody's® Mega-Bite studs are covered by US Patent No. D415, 954 and Canadian Patent No. 88,613. Woody's® Universal Template is Patent Pending.

Woody's® Manufacturer Warranty Returns

Call our customer service department for a Return Authorization Number. This number must be visible on the outside of the box. The product must be inspected by a Woody's technician to determine if the product is defective due to material, quality or workmanship before a final warranty determination is made. Proof of purchase is required. All returns to the manufacturer are for exchange only.



Page 151

BIG NUT

Recommended when using studs 1.325" and longer.

Description	Qty	p/n
Short - 1.325" Studs	90/Pk	6639-160
	96/Pk	6639-509
	102/Pk	4639-736
	135/Pk	6639-161
	144/Pk	6639-510
	153/Pk	4639-737
1000/Pk	4639-738	
Tall - 1.450" and longer Studs	90/Pk	6639-162
	96/Pk	6639-511
	102/Pk	4639-794
	135/Pk	6639-163
	144/Pk	6639-512
	153/Pk	4639-795
1000/Pk	4639-796	



2-Ply Track Application

Page 151

POWER POINT™ TRACTION KITS

Application	Qty	p/n
'14 XF 7000 LXR, 7000 SP, 8000 LXR, 8000 SP, 9000 LXR, 9000 SP 137" x 1.25" 2.86 P	1.375" Studs	96/Pk 6639-458
	1.375" Studs	144/Pk 6639-459
'14 ZR 6000, 7000 LXR, 7000 SP, 8000 LXR, 8000 SP, 9000 LXR, 9000 SP; '13 F 800 SP, 1100 SP, 1100T LXR, 1100T SP 129" x 1.25" 2.86 P	1.375" Studs	90/Pk 6639-141
	1.375" Studs	135/Pk 6639-142
'14 ZR 5000 LXR; '13 F 800 LXR, 1100 LXR 129" x 1.00" 2.86 P	1.080" Studs	90/Pk 6639-139
	1.080" Studs	135/Pk 6639-140
'14 SP 500; '12 F 800 SP, 1100 SP, 1100T LXR, 1100T SP; '10-'11 F Series SP, Z1 Turbo LXR, Z1 Turbo SP 128" x 1.25" 2.52 P	1.375" Studs	102/Pk 5639-783
	1.375" Studs	153/Pk 5639-784
'12 F 800 LXR, F 1100 LXR; '07-'13 F Series; '09-'11 CFR, Z1, Z1 Turbo; '11-'13 Sno Pro 500 128" X 1.00" Track 2.52 P	1.080" Studs	102/Pk 5639-099
	1.080" Studs	153/Pk 5639-100
'08-'14 T570, TZ1, TZ1 LXR 144" X 1.00" Track 2.52 P	1.080" Studs	114/Pk 5639-146
	1.080" Studs	114/Pk 5639-146
'11-'13 SP 600 SX 129"x 1.70" Track 2.86 P	1.875" Studs	90/Pk 5639-636



Page 151

POWER POINT™

60° Carbide Tip, 5/16" Thread, 1" Head. Support Plates sold separately.

Description	Qty	p/n
1.080 With Nyloc Nut	90/Pk	6639-135
	96/Pk	6639-493
	102/Pk	5639-072
	135/Pk	6639-136
	144/Pk	6639-494
153/Pk	5639-073	
1.375 With Nyloc Nut	90/Pk	6639-137
	96/Pk	6639-495
	102/Pk	5639-078
	135/Pk	6639-138
	144/Pk	6639-496
153/Pk	5639-079	
1.500 With Nyloc Nut	102/Pk	5639-081
	153/Pk	5639-082



Page 151

POWER PLATE™ BACKERS

Description	Qty	p/n
1.270"	90/Pk	6639-174
	96/Pk	6639-507
	102/Pk	5639-093
	135/Pk	6639-175
	144/Pk	6639-508
	153/Pk	5639-094
	1000/Pk	5639-095



Page 152

SUPER-LITE PLUS BACKERS

Single-Ply and 2-Ply application

Description	Color	Qty	p/n
1.450" x 5/16"	Black	102/Pk	5639-362
		153/Pk	5639-363
		1000/Pk	5639-364
	Green	102/Pk	5639-366
		153/Pk	5639-367
		1000/Pk	5639-368
	Orange	102/Pk	5639-370
		153/Pk	5639-371
		1000/Pk	5639-372
	White	102/Pk	5639-443
		153/Pk	5639-444



Page 152

POWER TOWER SUPPORT NUTS

Recommended when using studs 1.375" and longer.

Description	Qty	p/n
.750"	90/Pk	6639-176
	96/Pk	6639-513
	102/Pk	5639-096
	135/Pk	6639-177
	144/Pk	6639-514
	153/Pk	5639-097
	1000/Pk	5639-098

Stud Boy Limited Warranty

Liberty Products, Inc. warrants each product manufactured by it to be free of defects in workmanship and material while used for the purpose for which it is designed. Liberty Products, Inc. shall not be liable for damages or delays as a result of defects caused by defective workmanship or materials. Warranty is limited to the repair or replacement at Liberty Products of any defective part or product, within one (1) year of the delivery to the original purchaser, proof of purchase must accompany the product returned (freight prepaid). Liberty Products, Inc. shall be the sole judge of any defect, which might be claimed on the returned product. No other charges may be claimed in conjunction with the removal, reinstallation of such product. These products are designed and manufactured for use on snowmobiles on snow and ice only, use on other surfaces voids warranty. Warranty will be void if product has been misused, neglected, damaged or modified outside of Liberty Products, Inc. Does not cover bending, chipping, flaking or carbide breakage or loss from wear. Liberty Products, Inc. will not be liable for consequential damage or contingent liability arising from any total or partial failure to function of any product manufactured by it or any equipment on or in which it is used. No further warranty of any type is intended or implied or will by authorized to be made by Liberty Products, Inc.



Page 152

STUD DRILL

Description	p/n
5/16"	1639-629



Page 152

TRACK MARKER

Description	p/n
Track Marker	1639-520

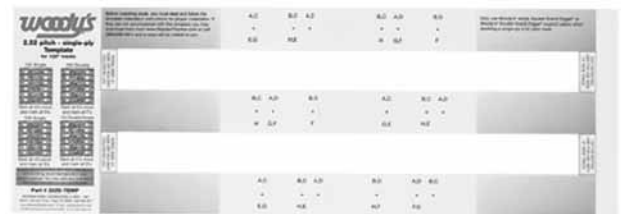

Page 152

STUD TEMPLATES

Application	p/n
'14 XF 7000, 8000, 9000 137" 2.86 P (2-Ply); '14 ZR 5000, 6000, 7000, 8000, 9000; '13 F 800, 1100, 1100T; 129" 2.86 P (2-Ply)	6639-532
'12-'14 F5, F570; '12 F 800, F 1100, F 1100 Turbo; '11-'14 Sno Pro 500; '07-'11 F Series; '09-'11 CFR, Z1 128" 2.52 P (2-Ply)	4639-443
'14 XF 7000 CC, 7000 CT, 8000 CC, 8000 CT, 9000 CC, 9000 CT; '13 XF 800 CT, 1100 CT, 1100T CT; '12-'13 XF 800, 1100, 1100T; '09-'11 CF 141" 3.0 P (Single-Ply)	4639-991
'08-'14 T570, TZ1, TZ1 LXR; '10-'11 Z1 Turbo EXT; '11 F8 EXT 144" (2-Ply)	5639-160
'11-'14 BC XT; '14 BC XT GS, BC 570 XTE 154" (Single-Ply)	5639-609
'09-'10 BC XT 156" (2-Ply); '10-'14 BC 570 151" (Single-Ply)	5639-461
'09 F Series Sno Pro, Z1 Turbo LXR, SP; '10 Sno Pro 500 128" (Single-Ply)	5639-428
'06-'08 CF 136" (2-Ply)	4639-344
All Purpose 15" X 121" Tracks (2-Ply)	4639-488
All Purpose 13.5" Tracks (2-Ply)	3639-589

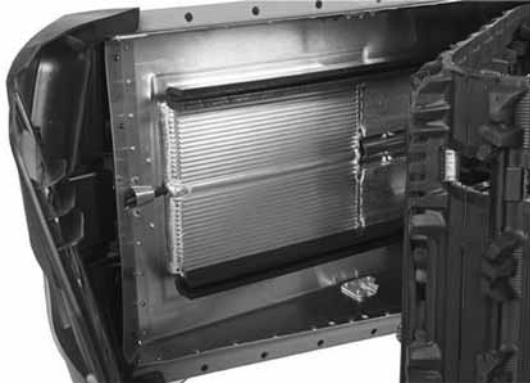

Page 152

TUNNEL PROTECTOR KIT

Required when installing studs on the models listed below. On liquid-cooled models not listed, the heat exchanger acts as a tunnel protector.

Application	p/n
'14 ZR 5000, 6000, 8000, 9000; '13 F 800, 1100, 1100T	6639-075
'12 F 800, 1100, 1100T*	6639-178
'14 XF 8000, 8000 CC, 8000 CT, 9000, 9000 CC, 9000 CT; '13 XF 800, 800 CT, 1100, 1100 CT, 1100T, XF 1100T CT	6639-118
'12 XF 800, 1100, 1100T*	6639-179
'14 M 8000 HCR, 9000 HCR; '12-'13 M 800 HCR, 1100T HCR	6639-207
'08-'14 F570, T570; '09-'14 BC 570	4639-771
'09-'14 BC Z1 XT; '12-'14 BC Z1 XT GS	5639-143
'09-'11 CF, CFR	4639-968
'06-'08 CF	4639-338

■NOTE: '12-'13 XF Sno Pro models with 1.60" track require Tunnel Protector kit 6639-118 or 6639-179. The wearstrips used in these kits have a taller profile for additional heat exchanger protection.

*'12 F, XF application includes models with a Tunnel Upgrade Kit installed.

'14 ZR 7000 and XF 7000 models have Standard Tunnel Protectors

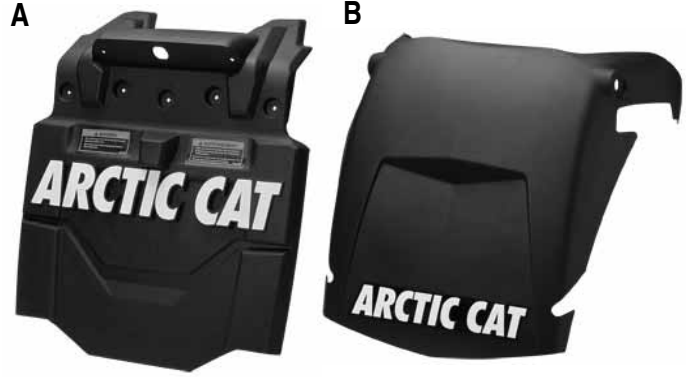

SHORT SNOWFLAP

Required when installing studs on the models listed below.

Application	p/n
(A) '09-'11 CF	5639-232
(B) '07-'08 JR; '07-'09 F Series; '09 Z1, Z1 Turbo	4706-462

General Maintenance

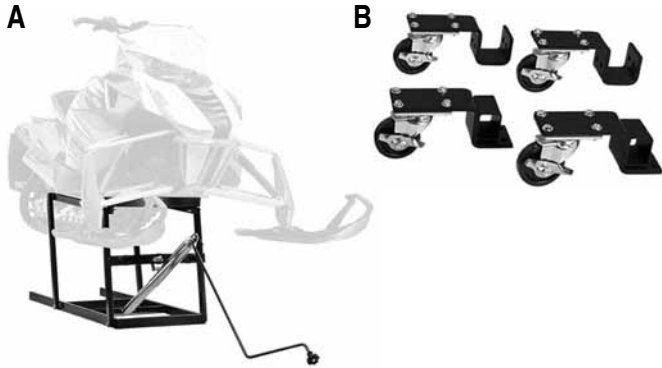

Page 153

SLED LIFT

Maximum lift capacity 625 lbs.

Description

(A) Sled Lift (Ship wt. 65 lb)
 (B) Wheel Kit (Ship wt. 15 lb)
 Replacement Jack

p/n
 4639-992
 4639-993
 5639-926

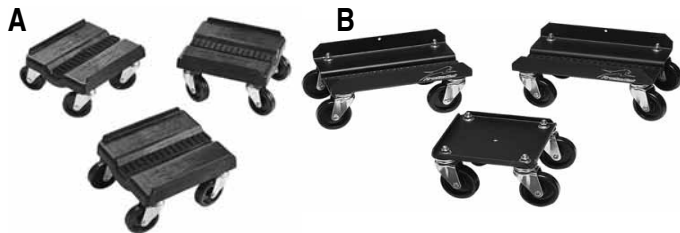

Page 153

CAT CADDY

Set of 3.

Description

(A) Plastic - Black
 (A) Plastic - Green
 Replacement Wheel - Push-in (Each)
 (B) Aluminum - Black
 Replacement Wheel - Threaded (Each)

p/n
 5639-873
 5639-874
 0641-264
 4639-766
 0641-535

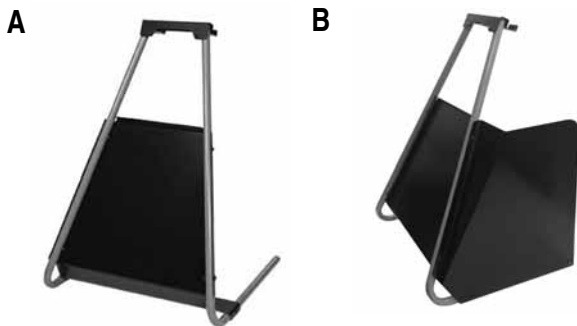

Page 153

JACK STAND

Description

(A) 31" High Black/Green
 (B) Side Plates, Pair

p/n
 6639-208
 6639-209

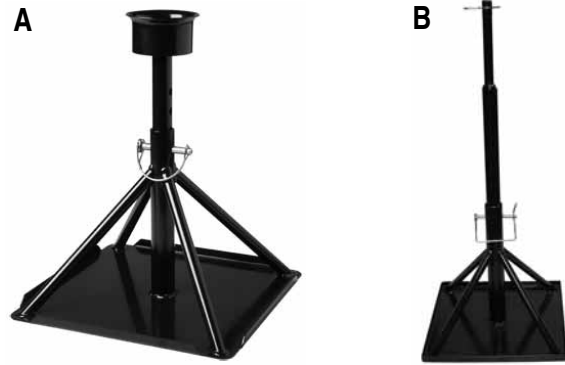

Page 154

HANDLEBAR STAND

Description

(A) Handlebar Stand
 (B) Steering Post Stand

p/n
 5639-152
 5639-946



Page 154

FRONT END LIFT

Description

Front End Lift

p/n
 5639-151



Page 154

SHOP DOLLY

Added freight charges may apply.

Description

Shop Dolly
 (Shipping: 46L x 25W x 11H, 70 lb)
 Replacement Strap
 Replacement Wheel (Each)

p/n
 5639-373
 5639-446
 5639-514



Page 155

A. STANDARD TIE-DOWNS

1" x 69", 1,000-lb Rating
Sold in pairs.

Description	p/n
Black	5639-411
Green	5639-415

B. DELUXE TIE-DOWNS

1.125" x 78", 1,200-lb Rating
Sold in pairs.

Description	p/n
Black	5639-423

C. RATCHET TIE-DOWNS

1.125" x 102" 1,200-lb Rating. Sold in pairs.

Description	p/n
Black	5639-424



Page 155

HEATED SHIELD ADAPTER

Application	p/n
Models with accessory outlet	5639-645



Page 155

TOOL BAG

Description	p/n
Tool Bag	5639-834



Page 155

A. TOW STRAP

Description	p/n
Tow Strap	4639-247

B. TOW ROPE

Description	p/n
Tow Rope	0636-577



Page 155

RACING TAPE

2" x 60-yd. rolls.

Description	p/n
Black	4639-579
Green	4639-580
Orange	5639-103



TOUCH-UP PAINT

Description	Application	1/2 oz.	12 oz.
Hood Paint			
Black (Gloss)	Black Hoods	0652-100	0652-022
Black (Flat)	'13 F, M, XF, TZ1, TZ1 Turbo, BC Z1 XT LTD	0652-187	0652-188
Apple Green Metallic	'10 F Series LE, TZ1 Turbo LE, Z1 Turbo LE	0652-152	0652-153
Cat Green	'00-'04 ZR; '01-'04 Z; '03-'04 FC; '04 MC	0652-099	0652-067
Desert Red Metallic	'11-'12 TZ1 LXR, TZ1 Turbo LXR, BC Z1 XT LTD	0652-160	0652-161
Orange * (Top Coat)	'14 ZR, M, XF Ltd; '11 CF SP; '07-'08 F; '06-'08 CF; '05-'08 M; '06-'07 Z; '05-'06 FC; '04-'06 KC	0652-105	0652-106
Pearl Cat Green	'05-'06 FC, SC, Z, ZR; '05-'07 M; '06-'07 CF; '09-'11 M8 HCR	0652-115	0652-117
Pearl White (Top Coat)***	'12 F, M, XF LTD	0652-175	0652-176
Pearl White (Base Coat)	'12 F, M, XF LTD	0652-181	0652-182
Sublime Green**	'11 M8 LTD, CF LTD, F8 LTD, Z1 Turbo LTD	0652-164	0652-165
Sunset Orange	'14 TZ1	0652-148	0652-149
Team Arctic Green	'14 ZR, M, XF	0652-197	0652-198
White Metallic * (Top Coat)	'08-'11 M Series SP; '11 CFR, TZ1 LXR, TZ1 Turbo LXR	0652-133	0652-134
Gold Metallic (Top Coat)		0652-173	0652-174
White (Base Coat)		0652-119	0652-120
Clear (Top Coat) (12-oz. Overspray Leveler)		0652-109	0652-166

* Metallic Top Coat only. You must first apply White (Base Coat) before applying color.

** Sublime Green (Base Coat) requires the use of Gold Metallic Top Coat.

*** Metallic Top Coat only. You must first apply Pearl White (Base Coat) before applying color.

Metal Paint		1/2 oz.	12 oz.
Black	Metal Parts	0652-110	0652-024
Bearcat Blue	'14 BC	0625-203	0652-204
Cat Green	'98-'11	0652-111	0652-077
Orange	'08-'14	0652-141	0652-142
Orange Metallic (Top Coat)****	'12 F, M, XF LTD	0652-183	0652-184
Orange Metallic (Base Coat)	'12 F, M, XF LTD	0652-179	0652-180
Pearl Cat Green	'08-'13	0652-144	0652-145
Pearl White (Top Coat)***	'12 F, M, XF LTD	0652-177	0652-178
Pearl White (Base Coat)	'12 F, M, XF LTD	0652-181	0652-182
Platinum	'02-'11	0652-112	0652-096
Sunset Orange	'14 TZ1	0652-148	0652-149
Team Arctic Green	'14 ZR, M, XF	0652-199	0652-200
White	'14 ZR, M, XF; '13 F, M, XF Ltd	0652-189	0652-190
Black	High Temp		0652-052

*** Metallic Top Coat only. You must first apply Pearl White (Base Coat) before applying color.

**** Metallic Top Coat only. You must first apply Orange Metallic (Base Coat) before applying color.

■NOTE: Models not listed have non-paintable, color-molded plastic.

Oil & Care

■ **NOTE:** Visit www.arcticcatlubricants.com for more oil information.

2014 MODEL YEAR SNOWMOBILE OIL APPLICATION CHART

Model	C-Tech2	C-Tech 4	APV	Formula 50	Capacity
120		X			0.6L (20.3 US oz.)
Sno Pro 500	X		X	X	2.6 L (2.75 US qt)
Bearcat 570/570 XT/ F570/T570	X		X	X	3.9 L (4.2 US qt)
ZR 5000 Models		X			3.1L (3.28 US qt)
ZR 6000 Models	X				3.7 L (3.9 US qt)
ZR/XF 7000 Models		X			3.9 L (4.2 US qt.)
ZR/M/XF 8000 Models	X		X		4.2 L (4.4 US qt)
ZR/M/XF 9000 Models		X			3.1 L (3.28 US qt)
F5	X		X	X	3.03 L (3.2 US qt)
Bearcat Z1 Model/TZ1 Models		X			3.8 L (4.0 US qt)



Page 156

APV SYNTHETIC OIL

Description

Quart
Gallon
2.5 Gallon
16 Gallon Drum
55 Gallon Drum

p/n

4639-349
5639-469
4639-347
2639-510
2639-509



Page 156

FORMULA 50 OIL

Description

Quart
Gallon
2.5 Gallon
16 Gallon Drum
16 Gallon Drum (50th Anniversary)
55 Gallon Drum

p/n

5639-475
5639-476
5639-477
5639-478
5639-910
5639-479



C-TEC2 SYNTHETIC OIL

Application

48 oz.
2.5 Gallon
16 Gallon Drum
55 Gallon Drum

p/n

6639-520
6639-521
6639-522
6639-523



C-TEC4 SYNTHETIC OIL

Description

Quart
Gallon
16 Gallon Drum
55 Gallon Drum

p/n

6639-524
6639-525
6639-526
6639-527



C-Tech Oil Change Kit

Description

1100 cc Twin Engine
1049 cc Triple Engine

p/n

6639-528
6639-529



Page 158

SYNTHETIC CHAIN LUBE

Description

8 oz.
15 oz.
2.5 Gallon

p/n

5639-038
6639-539
6639-117



Page 158

ARCTIC CAT CHAIN LUBE

Description

8 oz.
15 oz.
2.5 Gallon

p/n

4639-363
6639-538
1639-247



Page 158

SEMI-SYNTHETIC SHOCK OIL

Description

Quart

p/n

5639-530



Page 158

SYNTHETIC ACT REVERSE GEARCASE FLUID

Description

3 oz. ACT Non-Reverse
12 oz. ACT w/Reverse
15 oz. ACER (Engine) Reverse
Gallon

p/n

4639-361
4639-628
5639-219
5639-632

■NOTE: ACT Drive Gasket Sets (See pg. 71)



Page 158

ARCTIC CAT SHOCK OIL

Description

Quart

p/n

4639-366



Page 158

ACT FLUSH FLUID

Description

6 oz.
Gallon

p/n

4639-333
5639-847



Page 159

ARCTIC CAT ANTIFREEZE

Description

Gallon

p/n

0436-909



Page 158

SYNTHETIC SHOCK OIL

Description

Lt Wt - Quart
Med/Lt Wt - Quart
Med Wt - Quart

p/n

4639-367
4639-369
4639-368



Page 159

FUEL DE-ICER

Description

12 oz.

p/n

0436-906



Page 159

FUEL STABILIZER

Description
8 oz.

p/n
0436-907



FOX FLOAT FLUID

Specially made for use in the air chamber of FOX FLOAT Air Shox.

Description
8 oz.

p/n
4639-012



Page 159

DOT 4 BRAKE FLUID

Description
12 oz.

p/n
5639-848



Page 159

ARCTIC CAT ALL-TEMP GREASE

Description
14 oz.

p/n
4639-365



MISCELLANEOUS GREASE

Description
Throttle Cable Lube .5 oz.
Electric Start 2 cc
High Temperature .5 oz.
Dielectric 2.7 oz.

p/n
1056-053
1056-272
1056-077
1056-287

Page 159

FUEL INJECTOR & CARBURETOR CLEANER

Description
12 oz.

p/n
0436-904



Page 159

CAT CLEANER

Description
22 oz.

p/n
4639-371



Page 159

ENGINE PRESERVER

Description
12 oz.

p/n
0436-888



CHAIN LUBRICANT

Description
12 oz.

p/n
0436-903



HIGH OCTANE RACE FUEL

Description	p/n
110 Octane Race Fuel	
16 Gallon Drum	2639-098
55 Gallon Drum	2639-097
116 Octane Race Fuel	p/n
16 Gallon Drum	3639-620
55 Gallon Drum	3639-621

DRUM PUMP (NOT SHOWN)

Application	p/n
16 to 55 Gallon Drums	1639-249



VEHICLE WASH/CLEANER

Description	p/n
Gallon	4639-631
5 Gallon	4639-630
30 Gallon	4639-629



ALL PURPOSE CLEANER

Description	p/n
Gallon	4639-634
5 Gallon	4639-633
30 Gallon	4639-632



HEAVY DUTY CLEANER/DEGREASER

Description	p/n
Gallon	4639-637
5 Gallon	4639-636
30 Gallon	4639-635

CLEANING KIT

Kit includes two gallons each of the following cleaners: Vehicle Wash/Cleaner, All Purpose Cleaner, Heavy Duty Cleaner/Degreaser.

Description	p/n
Cleaning Kit	4639-666



LEATHER WATER REPELLENT

Description	p/n
Leather Water Repellent	4912-052



WATER/STAIN REPELLENT

Description	p/n
Water/Stain Repellent	4912-152

Misc Accessories



Page 160

CTEK BATTERY MAINTAINER

Description

12V 800 mA (Includes leads A, B, & D on this page)

p/n

5639-418



Page 160

CTEK BATTERY CHARGER/MAINTAINER

Description

12V 3.3 amp (Includes leads A, B, & D on this page)

p/n

5639-419

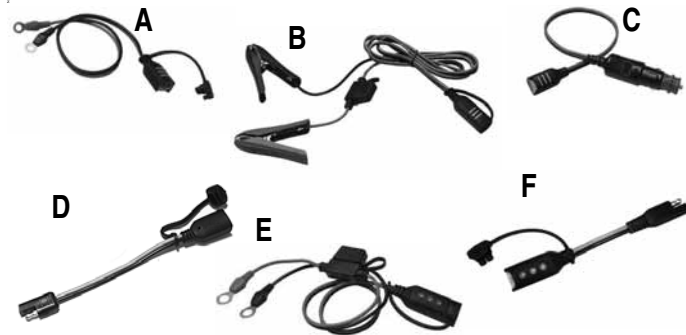

Page 160

CTEK BATTERY LEADS

NOTE: Comfort Indicators feature a three LED battery condition indicator.

Description

(A) Ring Terminals
 (B) Alligator Clips
 (C) Outlet
 (D) Style 21 Adapter
 (E) Comfort Indicator - Ring Terminals
 (F) Comfort Indicator - Style 21

p/n

5639-420
 5639-421
 5639-422
 5639-484
 5639-485
 5639-397



YUASA BATTERY MAINTAINER

Description

12V 900 mA

p/n

4639-998

A



B



YUASA BATTERY LEADS

Description

(A) Ring Terminals
 (B) Alligator Clips

p/n

5639-162
 5639-163



ACCESSORY ADAPTER

Description

2-Outlet
 3-Outlet

p/n

1639-623
 1639-624



DRIVE BELT HOLDER

Description

Drive Belt Holder

p/n

0636-659

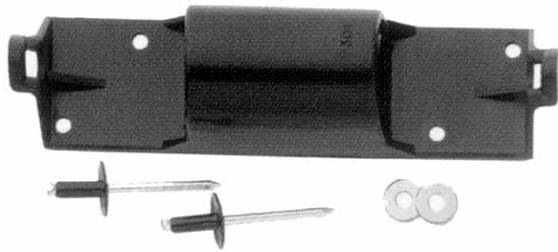

SPARK PLUG HOLDER

Description
Plug Holder

p/n
4639-549



SPARK PLUG CADDY

Description
Green

p/n
1639-618



TEMPERATURE GAUGE

Application
'99-'07 LC Models Except CF, F, FC, JR, M, SC, 4-Stroke

p/n
1639-217

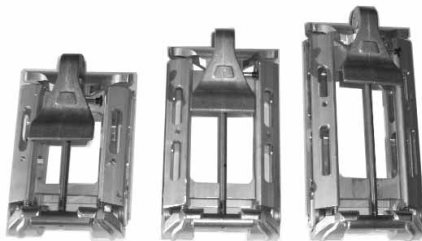

HANDLEBAR RISER KIT

Fits '07-'11 F Series Sno Pro; '09-'11 CFR, Z1

Description
4"
5"
6"

p/n
4639-599
4639-600
4639-601

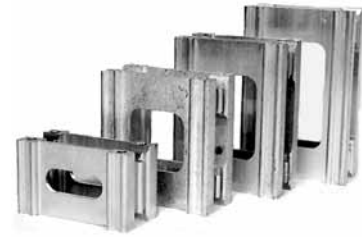

HANDLEBAR RISERS

Fits '02-'06 ZR; '03-'06 FC; '07-'11 F Series (Std)

Description

2.44"
3.00"
4.44"
5.44"
6.44"

p/n

0605-514
0605-884
0605-513
0605-491
0605-512

■NOTE: If 6.44" Riser Block (p/n 0605-512) is used on an '05-'06 FC with ACT Drive, it is necessary to install a longer Brake Line (p/n 1602-588).



RAIL BRACE KIT

Includes RH & LH rail braces and mounting hardware.

Application

'12-'14 M 153" & 162", XF 141"
'12-'14 M HCR 153"
'12-'14 M HCR 162"

Color

Black
Unpainted
Unpainted
Unpainted

p/n

5639-981
5639-983
5639-997
6639-086

SPEEDOMETER

Application

'12-'13 Sno Pro 600
'08-'11 Sno Pro 600

p/n

5639-993
4639-960



SNO PRO HANDLEBARS

Includes grips and heating elements.

Application

Heavy-Duty .095 Wall

'05-'13 Sno Pro

Color

Black
Green

p/n

1705-451
1705-155

Standard .083 Wall

'05-'13 Sno Pro

Black
Green

1705-450
1705-042

'11-'14' Sno Pro 500

Black

1705-482

THROTTLE LIMITER KIT, 50%

Application	p/n
'10-'14 Sno Pro 500	0709-088
'08-'13 Sno Pro 600	1705-359

ALUMINUM THROTTLE BLOCK

Application	p/n
'10-'14 Sno Pro 500	0709-084



THROTTLE LEVER BOLT KIT

Includes bolt, nut and nylon washer.

Application	p/n
Fits models with an aluminum throttle block	4639-336



SWAY BAR KITS

Application	p/n
'09-'14 BC 570 XT; '10-'14 BC Z1 XT	5639-441
'09-'14 BC 570	5639-200
'99-'07 PA, Z; '06-'08 BC	4639-322



HOOD LATCH REPAIR KIT

Includes two pins.

Application	p/n
'05-'11 CF, CFR, M Series	5639-498

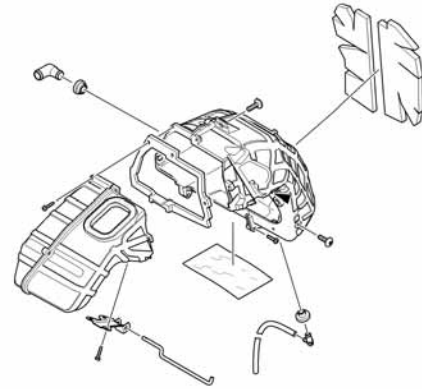

SPLIT AIRBOX KIT

Two-piece design provides easier access to engine components.

Application	p/n
'07-'08 JR; '08-'11 TZ1; '09-'11 BC Z1 XT, Z1	5639-934



SPARK PLUG CAPS

Description	p/n
(A) Silicone Rubber - Black	3006-367
(B) Standard Type - Black	3003-175



DEEP SNOW KIT

Reinforces the side panel and belly pan to reduce snow ingestion. Includes side panel screen.

Application	p/n
'12 F 800, F 1100, F 1100 Turbo, M 800, M 800 HCR, M 1100, M 1100 Turbo, M 1100 Turbo HCR, XF 800, XF 800 HC, XF 1100, XF 1100 Turbo, XF 1100 Turbo HC	0637-379



NGK® SPARK PLUGS

Arctic Cat ATV and Snowmobile applications in **BOLD**.

Iridium Spark Plugs

Description	p/n	Description	p/n
BR8EIX	0217-735	CR7EIX	0217-734
BR9EIX	0217-729	DR7EIX	0217-736
BR10EIX	0217-804	MR8AI-9	0217-806
CR6EIA-9	0217-733		

Standard Spark Plugs

Description	p/n	Description	p/n
AB7	0217-728	BR9ECS-5	0217-786
AB8	0217-808	BR9ES (SCREW CAPS)	0217-035
B2LM	0217-778	BR9ES (SOLID CAPS)	0217-700
B4LM	0217-770	BR9EYA	0217-709
B6L	0217-789	BR9HS-10	0217-756
B6S	0217-765	BR10ES (SOLID CAPS)	0217-634
B7HS	0217-044	BR10EYA	0217-714
B8ES	0217-029	BU8H	0217-744
B8HS	0217-043	BUHW	0217-751
B9ES	0217-015	BUHW-2	0217-750
B9HS-10	0217-791	CMR7A	0217-776
BKR6EKU	0217-793	CPR8E	0217-799
BM7A	0217-781	CR6E	0217-632
BMR4A	0217-767	CR6HS	0217-792
BMR6A	0217-753	CR6HSA	0217-725
BP4HS	0217-761	CR7E	0217-708
BP5HS	0217-783	CR7HS	0217-788
BP8H-N-10	0217-746	CR7HSA	0217-726
BPM6A	0217-763	CR8E	0217-705
BPM7A	0217-749	CR8EK	0217-711
BPM7Y	0217-764	CR9E	0217-738
BPM8Y	0217-752	CR9EH-9	0217-766
BPMR4A	0217-772	CR9EK	0217-755
BPMR6A	0217-773	CR10EK	0217-787
BPMR7A	0217-741	D7EA	0217-795
BPR2ES	0217-747	D8EA	0217-796
BPR4ES	0217-809	D8HA	0217-794
BPR4HS	0217-785	D9EA	0217-784
BPR5ES	0217-704	DCPR6E	0217-779
BPR5HS	0217-702	DCPR7E	0217-717
BPR6ES	0217-703	DCPR8E	0217-774
BPR6EFS	0217-748	DP8EA-9	0217-782
BPR6HS	0217-777	DPR6EA-9	0217-754
BPR7HS	0217-716	DPR7EA-9	0217-730
BPR9ES	0217-762	DPR8EA-9	0217-737
BPZ8H-N-10	0217-769	DPR8Z	0217-775
BPZ8HS-10	0217-757	DPR9EA-9	0217-790
BR6FS	0217-742	DR7EA	0217-713
BR6HS	0217-027	DR8EA	3304-919
BR7ES	0217-745	DR8ES	0217-771
BR7HS	0217-768	DR8ES-L	0217-740
BR7HS-10	0217-758	IZFR5G	0217-759
BR8ES (SCREW CAPS)	0217-034	KR8AI	0217-719
BR8ES (SOLID CAPS)	0217-701	LFR5A-11	0217-760
BR8HS	0217-739	LFR6A-11	0217-780
BR8HS-10	0217-743	PZFR6H	0217-641



FUEL PUMP REPAIR KITS

Description	p/n
Rectangular Mikuni	0636-272
Round Mikuni	0636-276
Pentagon Mikuni	1639-191
ATP 2/3	2639-095

SILICONE GASKET MAKER

Excellent for sealing around belly pan area and air box seams.

Description	p/n
Ultra Black Silicone Gasket Maker 70 ml	1639-834

HIGH TEMP SILICONE SEALANT

This sealant is recommended for sealing exhaust flanges, gaskets and crankcase halves of all Arctic Cat liquid-cooled engines.

Description	p/n
High Temperature Silicone 90 ml	0636-069

LOCTITE

Description	p/n
Loctite 242 Blue 10 ml	1639-814
Loctite 242 Blue 50 ml	1639-815
Loctite 263 Red 10 ml	5639-901
Loctite 263 Red 50 ml	5639-902
Loctite 271 Red 10 ml	1639-819
Loctite 271 Red 50 ml	1639-820
Loctite 290 Green Wicking 50 ml	1639-824
Loctite 609 Green Retaining 50 ml	1639-821
Loctite 620 Green Ret Hi Temp 10 ml	1639-826
Loctite 620 Green Ret Hi Temp 50 ml	1639-822

HANDLEBAR GRIP ADHESIVE

Description	p/n
Loctite 498 1 oz.	1048-058
Grip-It Glue 1 oz.	0441-510

CRANKCASE SEALANT

This sealant is recommended for sealing all Arctic Cat fan-cooled engine crankcase halves.

Description	p/n
Three-Bond Gasket Sealant	0636-070

CRANKCASE SEALANT

This sealant is recommended for Arctic Cat 2-Stroke liquid-cooled and 4-Stroke engines.

Description	p/n
Sealant, 100 gram tube	1048-070

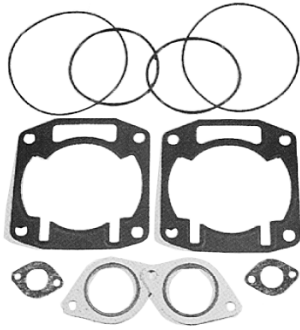

GASKET SETS

Application

340 F/C Twin
 370 F/C Twin
 440 F/C Twin (Except those listed below)
 440 F/C Twin ('99 Z 440; '00-'03 Z 440 Sno Pro)
 440 F/C Twin
 440 L/C Twin
 440 L/C Twin w/Reed
 500 F/C Twin (56 H.P.)
 500 F/C Twin (48 H.P.)
 500 L/C Twin, Non-APV "Laydown" (Sno Pro)
 500 L/C Twin, APV "Laydown"
 500 L/C Twin, APV
 500 L/C Twin, Non-APV
 530 L/C Twin

550 L/C Twin
 570 F/C Twin
 580 L/C Twin
 600 L/C Twin, C-Tek2 (Top End)
 600 L/C Twin, C-Tek2 (Complete)
 600 L/C Twin, APV "Laydown"
 600 L/C Twin, APV
 600 L/C Twin, Non-APV
 600 L/C Triple, APV
 600 L/C Triple
 650 L/C Twin
 660 L/C Triple (4-Stroke)
 660 L/C Triple (4-Stroke) Turbo
 700 L/C Twin, APV "Laydown"
 700 L/C Twin

800 L/C Twin, APV "Laydown" (Power Up)

800 L/C Twin, APV
 800 L/C Triple
 900 L/C Twin, APV
 900 L/C Triple
 1000 L/C Twin, APV "Laydown"
 1000 L/C Triple
 1100 L/C Twin (4-Stroke)

Year	p/n
'79-'00	0636-128
'99-'08	1639-123
'97-'06	0639-441
'99-'03	1639-605
'80-'96	0636-095
'90-'00	0636-635
'97-'00	0639-224
'86-'91	0636-093
'85-'87	0636-094
'04-'14	3639-539
'03-'06	2639-972
'01-'02	1639-988
'98-'02	0639-115
'87-'91	0636-097
'80-'85	0636-098
'91-'05	0636-812
'02-'14	2639-147
'91-'04	0636-812
'14	6639-613
'14	6639-614
'04-'09	3639-538
'01-'03	1639-989
'98-'02	0639-115
'01-'02	1639-990
'95-'00	0638-938
'88-'90	0636-409
'02	3006-296
'05-'07	3006-961
'03-'06	2639-973
'91-'96,	0636-813
'99-'00	
'10-'14	5639-520
'07-'09	4639-664
'01-'04	1639-991
'95-'01	0638-205
'03-'06	1639-991
'93-'97	0638-205
'07-'12	4639-663
'98-'02	0638-205
'07-'14	4639-619

ACT DRIVE GASKET SETS

Application

CF, M Series

F Series

Year	p/n
'08	2602-267
'07	2602-191
'07-'08	2602-192

ACT DRIVE CASE SEALANT

This sealant is recommended for ACT drive cases.

Description

Sealant, 70 ml

p/n
1048-063

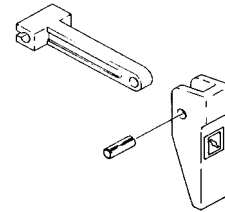

CHOKE LEVER REPAIR KIT

Application

Single or Dual Carburetor
 Triple Carburetor
 '01-'02 Triple Models

p/n
0636-062
0638-630
1639-835



TRACK CLIP TOOL

Description

Track Clip Tool

p/n
0744-068



OVERLOAD SPRING TOOL

Description

Overload Spring Tool

p/n
0744-022

FOX SHOCK REBUILD KITS

Description

IFP Shock
 Front Arm Adjustable Shock
 Clicker Shock
 Float w/o Reservoir
 Float w/Reservoir

p/n
1639-769
1639-770
1639-771
2604-796
2603-498

120



HAND WARMER KIT

Includes external hand warmer elements, wiring, and switch.

Application
'01-'14 120 Models

p/n
2639-019

A



B

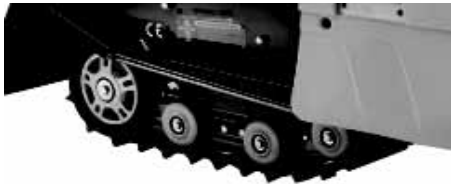

WHEEL KITS

Description

- (A) Ski Wheel Kit
(includes two 8" wheels and mounting hardware)
- (B) Rear Suspension Wheel Kit (Black)
(includes six idler wheels and mounting hardware)

Year	p/n
'01-'14	1639-795
'01-'14	5639-346



HEAVY DUTY SHOCK KIT

Includes two shock assemblies with springs.

Application
'01-'05 120 Models

p/n
4639-137

Upgrade Kits



CLUTCH GUARD UPGRADE KIT

Includes one-piece clutch guard and brake disc cover.

Application

'12-'13 F 800, M 800, XF 800
'12-'13 F 1100, 1100T, M 1100, 1100T, XF 1100, 1100T; '14 ZR 9000, M 9000, XF 9000

p/n

0637-428
0637-435

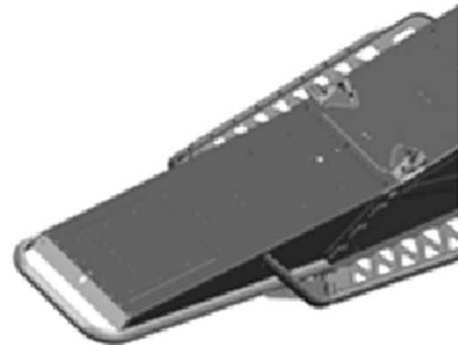

TUNNEL UPGRADE KIT

Converts '12 F and XF models to a '13 style flat-top tunnel. Includes rear tunnel, bumper, taillight housing, and snow-flap.

Application

'12 F 800, F 1100, F 1100 Turbo

'12 XF 800, XF 1100, XF 1100 Turbo

Color **p/n**

Unpainted	0637-387
Black	0637-388
Pearl White	0637-389
Unpainted	0637-391
Black	0637-392
Pearl White	0637-393

Helmet and Neck Brace Parts



EYEPORT FOAM PIECE

Description p/n
 '02-'14 4212-292
 5/8"

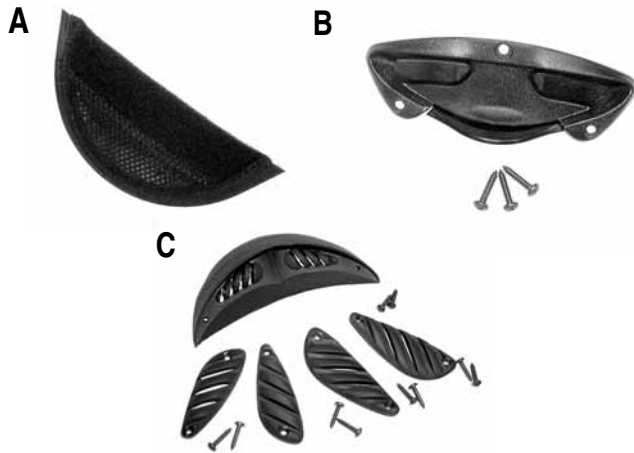

A. CHIN CURTAIN

Description p/n
 Chin Curtain 4212-290

B. CHIN VENT

Description p/n
 Chin Vent 4222-801
 Chrome Chin Vent 4252-032

C. SIDE AND TOP VENT COVER KIT

Description p/n
 Vent Cover Kit 4222-800
 Chrome Vent Cover Kit (Side Vents Only) 4252-033



VISOR

Description p/n
 Black (Gloss) 4212-101
 Chrome 4232-884
 Visor Screws Only (12/pkg) 4222-803



RATCHET KIT

Description p/n
 Ratchet Kit 4212-919
 Shield Screws Only (10/pkg) 4212-801

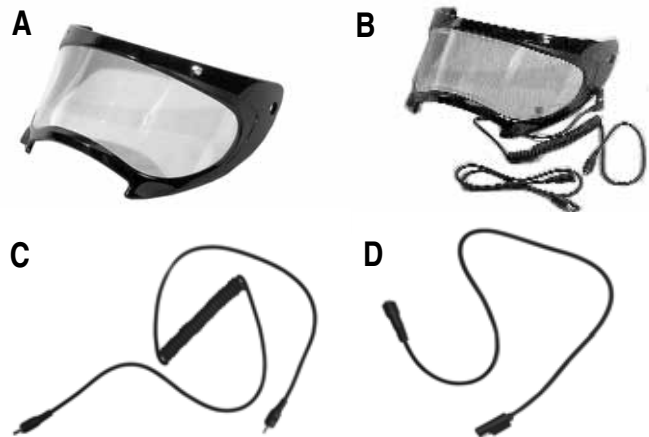

A. SHIELD

Description p/n
 (A) Clear 4212-845
 Smoke 4212-846
 Yellow 4212-847
 Silver Mirror 4222-740
 Chrome Frame/Clear 4232-880
 Chrome Frame/Smoke 4232-881
 Chrome Frame/Yellow 4232-882
 Chrome Frame/Silver Mirror 4232-883

B. ELECTRIC SHIELD KIT

Description p/n
 (B) Electric Shield Kit 4212-848
 (C) Replacement Elec. Coil Cord 4202-922
 (D) Replacement Elec. Dash Cord 4202-923
 Accessory Ext. Harness - 24" 1686-457
 Replacement Elec. Shield Only 4212-849
 Electric Shield Cord Converter (PFP coil cord to TXi dash) 4222-510
 Electric Shield Cord Converter (TXi coil cord to PFP dash) 4222-511

PFP & PFP YOUTH

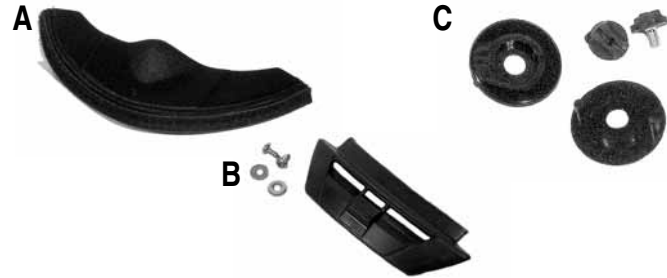

A. BREATH DEFLECTOR

Description p/n
Breath Deflector 4982-765

B. CHIN VENT

Description p/n
Chin Vent 4992-735

C. RATCHET KIT

Description p/n
Ratchet Kit 4912-122
Shield Screws Only (Metal Thread) 10/pkg 4212-801

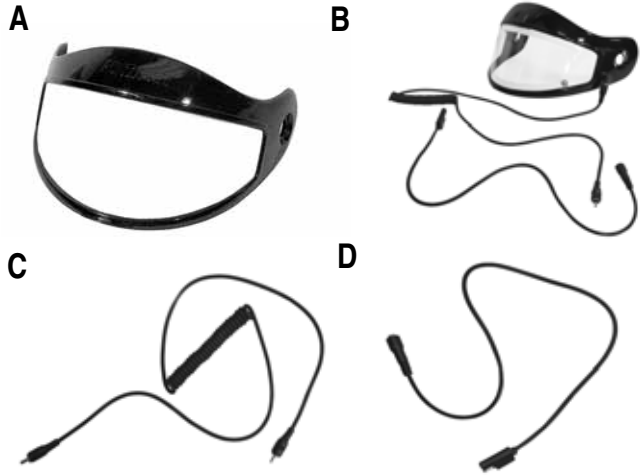

A. SHIELD

Description p/n
Clear 4212-810
Smoke 4212-811
Amber/Yellow 4212-812

B. ELECTRIC SHIELD KIT

Description p/n
(B) Electric Shield Kit 5222-500
(C) Replacement Electric Coil Cord 4202-922
(D) Replacement Electric Dash Cord 4202-923
Replacement Electric Shield Only 5222-501
Electric Shield Cord Converter (PFP 2011 coil cord to TXi dash) 4222-510
Electric Shield Cord Converter (TXi coil cord to PFP 2011 dash) 4222-511
Accessory Ext. Harness - 24" 1686-457
Accessory Ext. Harness - 66" 1436-643

PFP II



RATCHET KIT

Description

Ratchet Kit
Shield Screws Only (10/pkg)

p/n

4982-762
4212-801

A



B



A. SHIELD

Description

Clear
Smoke

p/n

4972-463
4972-464

B. ELECTRIC SHIELD KIT

Description

p/n

SNO PRO MX - NEW 2014



VISOR AND BREATH DEFLECTOR

Description	p/n
Black (Gloss, No Graphics)	5242-379
Sno Pro Orange Graphics - 2014	5242-380
Sno Pro Green Graphics - 2014	5242-370
Breath Deflector - 2014	5242-620

SNO PRO MX (Model PRO-X 2010-2013)



VISOR

Description	p/n
Black (Gloss, No Graphics)	5212-600
Sno Pro Orange Graphics (2013)	5232-400
Sno Pro Black Graphics (2013)	5232-360
Vent, Mouth	5232-409

TEAM ARCTIC MX - NEW 2014



VISOR AND BREATH DEFLECTOR

Description	p/n
Black (Gloss, No Graphics)	5242-609
Black (Flat, No Graphics)	5242-600
Team Arctic Green Graphics - Flat 2014	5242-410
Team Arctic Orange Graphics - Flat 2014	5242-400
Team Arctic Black Graphics - Flat 2014	5242-390
Breath Deflector - 2014	5242-621

SNO/ATV MX (MODEL 555)



VISOR, BREATH DEFLECTOR, AND COMPONENTS

Description	p/n
Black (Gloss)	4242-950
Chrome	4252-017
Flat Black	4282-920
Visor Screws (10/pkg)	4212-801
Front Vent	4242-951
Windguard	4242-954
Taillight	4242-952

TEAM ARCTIC MX (Model Moto X 2010-2013)



VISOR AND BREATH DEFLECTOR

Description	p/n
Black (Gloss, No Graphics)	5212-601
Team Arctic Green Graphics (2013)	5232-390
Team Arctic Black Graphics (2013)	5232-370
Team Arctic Orange Graphics (2013)	5232-380
Breath Deflector	5212-599

ATV OPEN FACE



VISOR

Description
Visor

p/n
4258-009

CROSSTEC

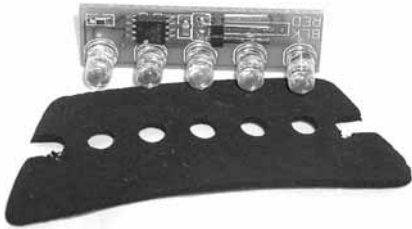

REAR LED LIGHT

Description
Rear LED Light Assy
Rear Light Cover

p/n
4262-901
4262-902



FRONT LIGHT LENS

Description
Front Light Lens
Light Button

p/n
4282-904
4282-903



MIC & SPEAKERS

Description
VRE Mic. Assy
VRE Mic. Foam Assy
Headset Speaker (Each)

p/n
4262-903
4262-904
4262-905



SHIELD

Description	p/n
Electric Shield Kit ('02-'09)	4282-869
(B) Electric Shield Only ('02-'09)	4282-865
Electric Shield Coil Cord (Not Shown)	4202-922
Electric Shield Power Cord (Not Shown)	4202-923
Accessory Ext. Harness - 24" (Not Shown)	1686-457
(A) Magnetic Power Cord	4262-907
(C) Crosstec/TXI Retrofit Headset Electric Shield Cord	4262-716
Clear Replacement Shield	4282-859
VRE Headset Electric Shield Cord (Not Shown)	4262-717
(D) Sun Shield - Smoke	4262-713
(D) Sun Shield - Yellow	4262-714
(D) Sun Shield - Orange	4262-715
Sun Shield Knob w/screw (Not Shown)	4272-997



BREATH DEFLECTOR

Description	p/n
Breath Deflector (XS-M)	4282-860
Breath Deflector (L-2XL)	4282-861

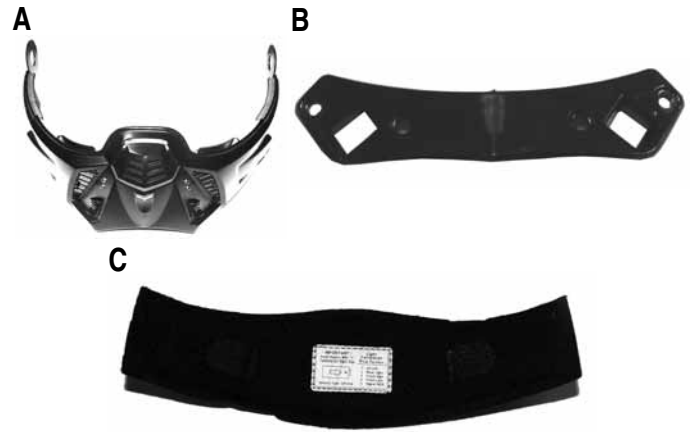
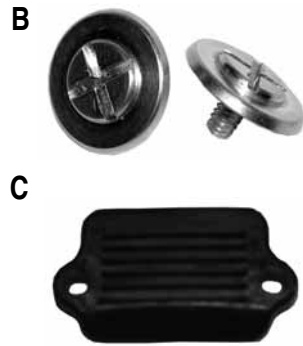

RATCHET KIT

Description

- (A) Ratchet Kit
- Ratchet Disc Set
- (B) Aluminum Shield Screws (Pair)
- (C) Top Ratchet Bar

- p/n**
- 4262-911
- 4282-901
- 4262-910
- 4282-902

CHINBAR AND CHIN PAD

Description

- (A) Replacement Chinbar
- (B) Chinbar Lock Plate
- (C) Chin Pad

- p/n**
- 4272-998
- 4282-223
- 4262-933



CHIN CURTAIN

Description

- (A) Chin Curtain
- (B) Extended Chin Curtain

- p/n**
- 4262-912
- 4282-900



VRE MUSIC ADAPTER CORD

Description

- (A) Adapter Cord
- (B) Cat Comm MP3/Satellite Radio Cord - 80"

- p/n**
- 4262-906
- 4292-950

VISOR

Description

- Visor - Black (2007-2009)

- p/n**
- 4272-999

Arctic Cat Neck Brace

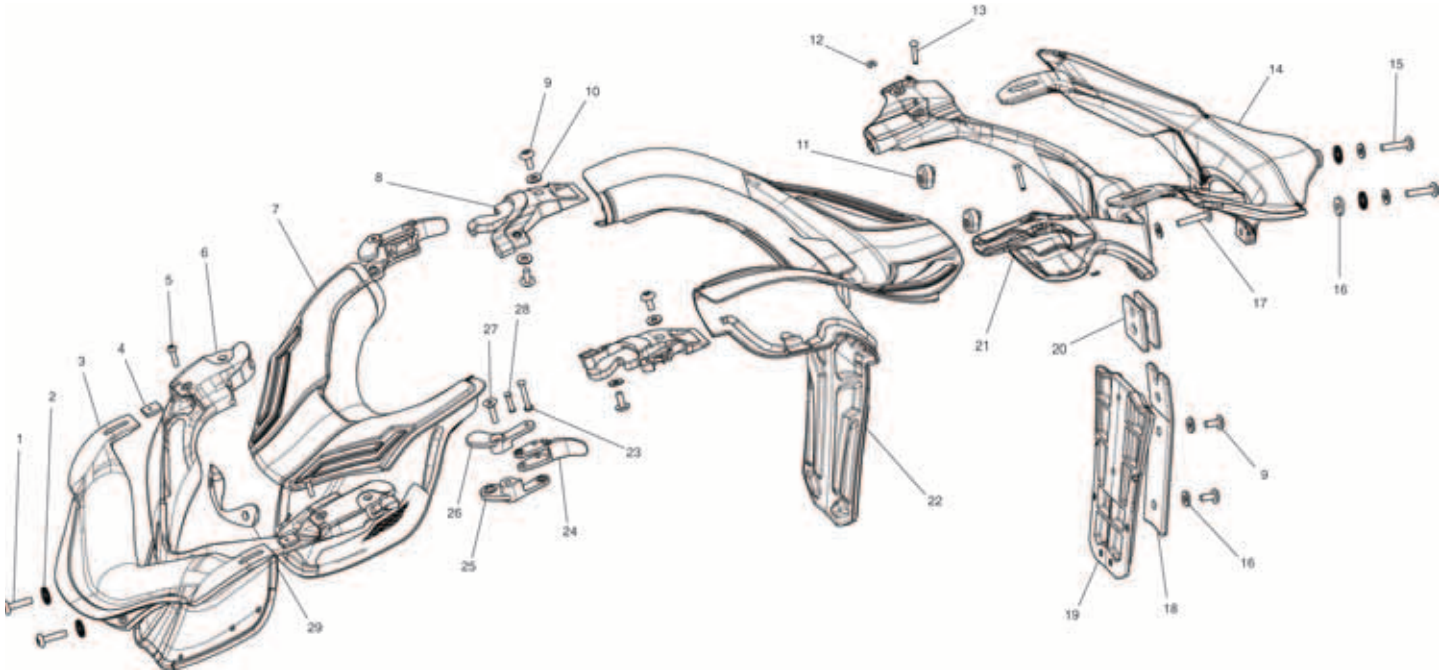

Parts/Components List		QTY
1	BHCS M4 18	2
2	Serrated Washer	2
3	Front Top Plastic	1
4	Front Top Screwplate	2
5	M3 Bolt	2
	Front Lower Plastic	
7	5232-812 / 5232-813	1
8	5232-808 / 5232-809 / 5232-810 / 5232-811	2
9	5232-808 / 5232-809 / 5232-810 / 5232-811	6
10	5232-808 / 5232-809 / 5232-810 / 5232-811	5
11	5232-814 / 5232-815	2
12	5232-814 / 5232-815	2
13	5232-814 / 5232-815	2
14	5232-814 / 5232-815	1
15	5232-814 / 5232-815	2

Parts/Components List		QTY
16	5232-814 / 5232-815	4
17	5232-814 / 5232-815	1
18	10° Strut	1
19	Thoracic	1
20	Shim	2
21	5232-814 / 5232-815	1
22	5232-812 / 5232-813	1
23	5232-807	2
24	5232-807	2
25	5235-807	2
26	5232-807	2
27	5232-807	2
28	5232-807	2
29	Front Screw Plate	1

High Altitude Kits

Models	Altitude	p/n	Components
F 570 T 570 Bearcat 570	5-9000 ft.	5639-489	(2) 6505-029 Pilot Jet 35 (3) 0746-695 Cam Arm - Wide - 67g** (1) 0748-700 Driven Cam - 36° (N)*
	Over 9000 ft.	5639-490	(2) 6505-029 Pilot Jet 35 (3) 0746-669 Cam Arm - Wide - 60g** (1) 0748-700 Driven Cam - 36° (N)*
Bearcat 570 XT Bearcat 570 XTE	5-9000 ft.	5639-627	(2) 6505-029 Pilot Jet 35 (3) 0746-670 Cam Arm - Wide - 65g** (1) 0748-700 Driven Cam - 36° (N)*
	Over 9000 ft.	5639-490	(2) 6505-029 Pilot Jet 35 (3) 0746-669 Cam Arm - Wide - 60g** (1) 0748-700 Driven Cam - 36° (N)*
Bearcat Z1 XT	5-9000 ft.	5639-935	(3) 0746-828 Cam Arm** - 57g
Bearcat Z1 XT LTD	Over 9000 ft.	5639-936	(3) 0746-829 Cam Arm** - 52g (1) 0646-433 Clutch Spring - Gold Stripe - 75/275 lb
Bearcat Z1 XT GS	Over 9000 ft.	5639-937	(3) 0746-828 Cam Arm** - 57g (1) 0646-433 Clutch Spring - Gold Stripe - 75/275 lb
TZ1 (Non Turbos)	5-9000 ft.	4639-687	(3) 0746-678 Cam Arm - Wide - 55g** (1) 0748-662 Driven Cam - 36°*
	Over 9000 ft.	4639-639	(3) 0746-663 Cam Arm - Wide - 52g** (1) 0748-662 Driven Cam - 36°*
ZR 5000	5-9000 ft.	5639-978	(3) 0746-663 Cam Arm - 52g
	Over 9000 ft.	5639-979	(3) 0746-705 Cam Arm - Wide - 49g**
ZR 6000	5-9000 ft.	6639-608	(1) 0746-842 Cam Arm - 61.5g** (1) 0748-770 Driven Cam - 36°
	Over 9000 ft.	6639-609	(3) 0746-843 Cam Arm - 56.5g** (1) 0748-770 Driven Cam - 36°
ZR 7000	5-9000 ft.	6639-610	(3) 0746-844 Cam Arm - 53g**
	Over 9000 ft.	6639-611	(3) 0746-845 Cam Arm - 48g**
ZR 8000	5-9000 ft.	6639-586	(3) 0746-703 Cam Arm - Wide - 68g** (1) 0748-770 Driven Cam - 36°
	Over 9000 ft.	6639-588	(3) 0746-670 Cam Arm - Wide - 65g** (1) 0748-770 Driven Cam - 36°
ZR 9000	5-9000 ft.	5639-978	(3) 0746-663 Cam Arm - 52g
	Over 9000 ft.	5639-979	(3) 0746-705 Cam Arm - Wide - 49g**
F5	5-9000 ft.	4639-639	(3) 0746-663 Cam Arm - Wide - 52g** (1) 0748-662 Driven Cam - 36°*
	Over 9000 ft.	4639-640	(3) 0746-792 Cam Arm - Wide - 47g** (1) 0748-662 Driven Cam - 36°*
Sno Pro 500	5-9000 ft.	5639-507	(3) 0746-666 Cam Arm - Wide - 55g**
	Over 9000 ft.	5639-508	(3) 0746-661 Cam Arm - Wide - 52g**
XF 7000	3-6000 ft.	6639-625	(3) 0746-678 Cam Arm - Wide - 55g**
	6-9000 ft.	6639-610	(3) 0746-844 Cam Arm - 53g**
	Over 9000 ft.	6639-611	(3) 0746-845 Cam Arm - 48g**
XF 8000 LXR, SP	3-6000 ft.	6639-603	(3) 0746-671 Cam Arm - Wide - 70g** (1) 0748-770 Driven Cam - 36°
	6-9000 ft.	6639-586	(3) 0746-703 Cam Arm - Wide - 68g** (1) 0748-770 Driven Cam - 36°
	Over 9000 ft.	6639-588	(3) 0746-670 Cam Arm - Wide - 65g** (1) 0748-770 Driven Cam - 36°
XF 9000	Over 6000 ft.	6639-612	(1) 0748-772 Driven Cam - 42/40°
M 8000 XF 8000 HC	0-3000 ft.	6639-589	(3) 0746-672 Cam Arm - Wide - 75g** (1) 0748-772 Driven Cam - 42/40°
	3000-6000 ft.	4639-641	(3) 0746-671 Cam Arm - Wide - 70g**
	Over 9000 ft.	4639-318	(3) 0746-694 Cam Arm - Wide - 63g**

* w/bearing assembly ** w/set screw

■NOTE: M 8000 and XF 8000 HC set up at the factory for an altitude of 6-9000 ft.

■NOTE: For more information on the High Altitude Kit Exchange Program, see page 1.

2014 Optional Rear Suspension Springs

Model	Standard Rear Arm Spring	Optional Rear Arm Spring	Spring Type
BC 570, T570, TZ1	1704-146/147	L 1704-678/679 H 1704-360/361	SQUARE SQUARE
F5/F570	1704-504/505	L 1704-576/577 H 1704-710/711	SQUARE SQUARE
ZR 8000 ZR 9000 RR/Sno Pro	1704-576/577	L 1704-354/355 H 1704-560/561	SQUARE SQUARE
BC XT GS	1704-842/843	L 1704-852/853 H 2704-556/557	SQUARE SQUARE
BC 570 XT/BC Z1 XT	1704-852/853	L 1704-562/563 H 1704-842/843	SQUARE SQUARE
XF 7000 LXR (141)/ XF 9000 LXR/XF 8000 LXR (141)	2703-502	L 2703-386* H 2704-010*	COIL COIL
Sno Pro 500	1704-382/383	L N/A H 2704-382/383	SQUARE SQUARE
ZR 6000 R CC	2704-382 R	L 2704-384/385	SQUARE
	2704-383 L	H 2704-380/381	SQUARE
ZR 6000 R SX	2704-380 R	L 2704-224/225	SQUARE
	2704-381 L	H N/A	SQUARE

* Coil over shock

■NOTE: For prior model-year applications, see the Quick Reference Guide at Cat Tracker Online under Quick Links on the right side of the webpage.

Drive Belt Application Guide

1994	
Puma, Puma Dlx, Puma 2-Up.....	0227-103
Jag, Jag 440Z.....	0227-103
Cheetah Models.....	0227-103
Cougar.....	0227-103
Pantera.....	0227-103
Prowler EFI.....	0227-103
EXT 580 Models.....	0627-012
Panther Dix.....	0227-103
Wildcat EFI.....	0627-011
ZR Models.....	0627-012
Thundercat.....	0627-010

1995	
Puma, Puma Dlx, Puma 2-Up.....	0227-103
Jag, Jag Dlx.....	0227-103
Panther.....	0227-103
Bearcat 340.....	0627-013
Bearcat 440 & 550.....	0627-014
Cougar.....	0627-012
Prowler.....	0627-012
Pantera.....	0627-012
EXT.....	0627-012
EXT Powder Special.....	0627-010
Wildcat, Wildcat Touring.....	0627-010
Thundercat.....	0627-010
Z440.....	0627-012
ZR440, ZR580.....	0627-012
ZR700.....	0627-010
ZRT800.....	0627-010

1996	
Puma, Puma Dlx, Puma 2-Up.....	0227-103
Jag, Jag Dlx, Jag L/C.....	0227-103
Z440, Panther Dlx, Panther L/C.....	0627-012
Bearcat 340.....	0627-013
Bearcat 440 & 550.....	0627-014
Cougar, Cougar 2-Up, Cougar M/C.....	0627-012
Pantera.....	0627-012
EXT EFI Models.....	0627-012
EXT 580.....	0627-012
EXT 580 Powder Special.....	0627-010
Wildcat Models.....	0627-010
Thundercat, ZRT 800, ZRT 600.....	0627-010
ZR 580 Models, ZR440.....	0627-012

1997	
Puma, Puma Dlx, Puma 2-Up.....	0627-012
Jag, Jag Dlx.....	0627-012
Panther, Panther L/C.....	0627-012
Z440, ZL440.....	0627-012
Bearcat 340.....	0627-013
Bearcat 440 & 550.....	0627-014
Cougar, Cougar M/C.....	0627-012
Pantera.....	0627-012
EXT EFI Models.....	0627-012
Powder Special EFI.....	0627-012
Thundercat, ZRT 800, ZRT 600.....	0627-010
ZR 580, ZR440.....	0627-010
EXT 600, Powder Extreme.....	0627-010
Powder 580 Carb.....	0627-010

1998	
Jag 340, Panther 340.....	0627-012
Jag 440, Jag 440 DLX.....	0627-012
Z 440, Panther 440.....	0627-012
Panther 550.....	0627-021
Bearcat 340.....	0627-013
Bearcat 440, Bearcat WT.....	0627-014
Cougar, Cougar Dlx, Cougar M/C.....	0627-021
Pantera 580.....	0627-021
Pantera 800.....	0627-020
EXT EFI.....	0627-020
EXT EFI DLX.....	0627-021
EXT 600, EXT 600 Touring.....	0627-020
Powder Special, Powder Special EFI.....	0627-020
Powder Extreme.....	0627-020
Thundercat, Thundercat M/C.....	0627-020
ZRT 600, ZRT 800.....	0627-020
ZR 600, ZR 600 EFI.....	0627-020
ZL 440.....	0627-021
ZL 500, ZR 500.....	0627-020
ZR 440.....	0627-020

1999	
Jag 340 DLX, Panther 340.....	0627-012
Jag 440, Jag 440 DLX.....	0627-012
Panther 440.....	0627-012
Panther 550.....	0627-021
Bearcat 340, Bearcat 440 I.....	0627-013
Bearcat 440 II, Bearcat WT.....	0627-014
Pantera 580 EFI.....	0627-021
Pantera 800.....	0627-020
Triple Touring 600.....	0627-020
Powder Special 500 EFI.....	0627-020
Powder Special 600 Models.....	0627-020
Powder Special 700.....	0627-020

1999 (cont)	
Thundercat, Thundercat M/C.....	0627-020
Z 370.....	0627-021
Z 440.....	0627-021
ZL 440.....	0627-021
ZL 500 Models, ZL 600 Models.....	0627-020
ZR 500 Models.....	0627-020
ZR 600 Models.....	0627-020
ZR 700.....	0627-020
ZRT 600, ZRT 800.....	0627-020

2000	
Bearcat 340.....	0627-013
Bearcat 440 I/440 II/WT.....	0627-014
Pantera Models.....	0627-020
Panther 340/440.....	0627-012
Panther 550.....	0627-021
Powder Special Models.....	0627-020
Thundercat Models.....	0627-020
Triple Touring 600.....	0627-020
Z Models.....	0627-021
ZL 440/550.....	0627-021
ZL 500/580/600/700.....	0627-020
ZR Models.....	0627-020
ZRT Models.....	0627-020

2001	
Bearcat W/T.....	0627-014
Mountain Cat Models.....	0627-020
Pantera Models.....	0627-020
Panther 370 Models.....	0627-013
Panther 440 Models.....	0627-012
Panther 550.....	0627-021
Thundercat.....	0627-020
Triple Touring 600.....	0627-020
Z Models.....	0627-021
ZL Models.....	0627-020
ZR Models.....	0627-020
ZRT Models.....	0627-020

2002	
Bearcat W/T.....	0627-014
Mountain Cat Models.....	0627-020
Pantera 550.....	0627-021
Pantera Models (EFI).....	0627-020
Panther Models.....	0627-021
Thundercat.....	0627-020
Z Models.....	0627-021
ZL Models.....	0627-020
ZR Models.....	0627-020
ZRT 600.....	0627-020

2003	
Bearcat W/T.....	0627-026
Firecat 500/600 Models.....	0627-020
Firecat 700 Models.....	0627-020/035*
4-Stroke Touring/Trail.....	0627-013
Mountain Cat Models.....	0627-020
Pantera 550.....	0627-021
Pantera Models (EFI).....	0627-020
Panther Models.....	0627-021
Z Models.....	0627-021
ZL Models.....	0627-020
ZR Models.....	0627-020/035*

2004	
Bearcat 570.....	0627-013
Bearcat W/T.....	0627-033
Firecat 500 Models.....	0627-020
Firecat 600/700 Models.....	0627-031
King Cat.....	0627-020
Mountain Cat Models.....	0627-020
Pantera 550.....	0627-021
Pantera Models (EFI).....	0627-020
Panther Models.....	0627-021
Sabercat 500.....	0627-020
Sabercat 600/700 Models.....	0627-031
T660 Touring.....	0627-021
T660 Turbo Models.....	0627-028
Z Models.....	0627-021
ZR Models.....	0627-032

2005	
Bearcat 570.....	0627-013
Bearcat W/T.....	0627-033
Firecat 500 Models.....	0627-034
Firecat 600/700 Models.....	0627-034
King Cat.....	0627-020
M-Series.....	0627-036
Pantera 550.....	0627-021
Pantera 600 EFI.....	0627-020
Panther Models.....	0627-021
Sabercat 500.....	0627-020
Sabercat 600/700 Models.....	0627-035
T660 Touring.....	0627-021
T660 Turbo Models.....	0627-028
Z Models.....	0627-021
ZR 900 Models.....	0627-032

2006	
Bearcat 570.....	0627-013
Bearcat W/T.....	0627-033
Bearcat W/T Turbo.....	0627-049
Crossfire Models.....	0627-036
Firecat 500 Models.....	0627-044
Firecat 600 EFI r.....	0627-020
Firecat 600/700 Models (w/o Reverse).....	0627-044
Firecat 700 EFI r.....	0627-035
King Cat Models.....	0627-020
M-Series Models.....	0627-036
Panther 370/570 Models.....	0627-021
Panther 660 Models.....	0627-013
Sabercat 500/600 Models.....	0627-020
Sabercat 700 Models.....	0627-035
T660 Touring.....	0627-013
T660 Turbo Models.....	0627-048
Z Models.....	0627-021
ZR 900 EFI Models.....	0627-045

2007	
Bearcat 570.....	0627-013
Bearcat W/T.....	0627-033
Bearcat W/T Turbo.....	0627-049
Crossfire 5/6/8.....	0627-046
Crossfire 1000.....	0627-060
F-Series 5/6/8.....	0627-046
F1000.....	0627-060
Jaguar Z1.....	0627-047
M-Series.....	0627-046
Panther 370/570.....	0627-021
Panther 660.....	0627-013
T660.....	0627-048
Z 370/570.....	0627-021

2008	
Bearcat 570.....	0627-013
Bearcat W/T.....	0627-033
Bearcat W/T Turbo.....	0627-049
Crossfire 5/6/8.....	0627-046
Crossfire 1000.....	0627-060
F-Series 5/6/8/570.....	0627-046
F1000.....	0627-060
Jaguar Z1.....	0627-047
M-Series 6/8.....	0627-046
M1000.....	0627-060
Panther 370.....	0627-021
Panther 660.....	0627-013
600 Sno Pro.....	0627-066
T500/T570.....	0627-046
TZ1.....	0627-047

2009	
Bearcat 570.....	0627-067
Bearcat 570 XT.....	0627-046
Bearcat Z1 XT.....	0627-047
Crossfire 500.....	0627-067
Crossfire 6/8/R8.....	0627-046
Crossfire 1000/R1000.....	0627-060
F5/570.....	0627-067
F6/8.....	0627-046
F1000 Sno Pro.....	0627-060
M6/8/HCR.....	0627-046
M1000.....	0627-060
T500/570.....	0627-067
TZ1.....	0627-047
TZ1 Turbo.....	0627-066
Z1.....	0627-047
Z1 Turbo.....	0627-066
600 Sno Pro (Sno Cross).....	0627-070
600 Sno Pro (Cross Country).....	0627-066

2010	
Bearcat 570.....	0627-067
Bearcat 570 XT.....	0627-046
Bearcat Z1 XT.....	0627-047
Crossfire 6.....	0627-046
Crossfire 8, CFR 8, CFR 1000.....	0627-060
F5 LXR/570.....	0627-067
F6 Sno Pro/8/8 Sno Pro.....	0627-046
M6/8/HCR.....	0627-046
M1000.....	0627-060
T570.....	0627-067
TZ1.....	0627-069
TZ1 Turbo/LXR.....	0627-073
Z1.....	0627-069
Z1 Turbo/EXT/ Sno Pro.....	0627-073
Sno Pro 500.....	0627-047
Sno Pro 600 (Sno Cross).....	0627-075
Sno Pro 600 (Cross Country).....	0627-076

2011	
Bearcat 570/LTD.....	0627-067
Bearcat 570 XT.....	0627-046
Bearcat Z1 XT/LTD.....	0627-047
Crossfire 6.....	0627-046
Crossfire 8, CFR 8, CFR 1000.....	0627-060
F5 LXR/570.....	0627-067

F6 Sno Pro/8 EXT/LXR/	
8 Sno Pro LTD.....	0627-046
M6/8/HCR.....	0627-046
M1000 Sno Pro.....	0627-060
T570.....	0627-067
TZ1/LXR LTD.....	0627-069
TZ1 Turbo LXR LTD.....	0627-073
Z1 LXR.....	0627-069
Z1 Turbo EXT/LXR/Sno Pro.....	0627-073
Sno Pro 500.....	0627-047
Sno Pro 600 (Sno Cross).....	0627-075
Sno Pro 600 (Cross Country).....	0627-076

2012	
BC 570.....	0627-067
BC 570 XT.....	0624-046
BC Z1 XT.....	0627-047
F5 LXR, F570.....	0627-067
F 800.....	0627-083
F 1100.....	0627-081
F 1100 Turbo.....	0627-082
M 800.....	0627-084
M 1100.....	0627-081
M 1100 Turbo.....	0627-082
T570.....	0627-067
TZ1 Touring.....	0627-069
TZ1 Turbo Touring.....	0627-082
XF 800.....	0627-083
XF 1100.....	0627-081
XF 1100 Turbo.....	0627-073
XF 800 High Country.....	0627-084
Sno Pro 500.....	0627-047
Sno Pro 600.....	0627-085

2013	
Bearcat 570.....	0627-067
Bearcat 570 XT.....	0627-046
Bearcat Z1 XT.....	0627-047
F5 LXR, F570.....	0627-067
F800.....	0627-083
F1100.....	0627-081
F1100 Turbo.....	0627-082
M800.....	0627-084
M1100.....	0627-081
M1100 Turbo.....	0627-082
T570.....	0627-067
TZ1.....	0627-069
TZ1 Turbo.....	0627-073
XF800.....	0627-083
XF 800 High Country.....	0627-084
XF1100.....	0627-081
XF1100 Turbo.....	0627-082
Sno Pro 500.....	0627-047
Sno Pro 600.....	0627-086

2014	
Bearcat 570.....	0627-067
Bearcat 570 XT.....	0627-046
Bearcat Z1 XT.....	0627-047
Bearcat Z1 XT GS.....	0627-073
F5.....	0627-067
F570.....	0627-067
M 8000.....	0627-084
M 9000.....	0627-082
T570.....	0627-067
TZ1.....	0627-069
XF 7000.....	0627-070
XF 8000.....	0627-083

Drive Belt Dimension Chart

BELT P/N	LENGTH	WIDTH
0100-088	43.125 ± .188 inch	1.188 inch
0100-092	43.813 ± .188 inch	1.250 inch
0227-011	44.000 ± .188 inch	1.250 inch
0227-014	45.500 ± .188 inch	1.250 inch
0227-016	45.063 ± .188 inch	1.250 inch
0227-019	43.250 ± .188 inch	1.250 inch
0227-020	46.688 ± .188 inch	1.250 inch
0227-030	43.500 ± .188 inch	1.375 inch
0227-100	45.500 ± .188 inch	1.375 inch
0227-103	43.625 ± .125 inch	1.375 inch
*0627-002	43.625 ± .188 inch	1.375 inch
*0627-004	43.625 ± .188 inch	1.375 inch
*0627-006	43.625 ± .188 inch	1.375 inch
*0627-010	47.750 ± .188 inch	1.375 inch
*0627-011	45.750 ± .188 inch	1.375 inch
*0627-012	47.750 ± .188 inch	1.375 inch
0627-013	49.000 ± .188 inch	1.437 inch
0627-014	49.000 ± .188 inch	1.437 inch
*0627-020	48.071 ± .188 inch	1.406 inch
*0627-021	47.750 ± .188 inch	1.385 inch
*0627-031	47.750 ± .178 inch	1.382 inch
*0627-032	44.570 ± .178 inch	1.448 inch
*0627-033	50.285 ± .188 inch	1.437 inch

BELT P/N	LENGTH	WIDTH
*0627-034	44.024 ± .178 inch	1.448 inch
*0627-035	47.750 ± .178 inch	1.400 inch
*0627-036	45.024 ± .178 inch	1.448 inch
*0627-044	44.706 ± .178 inch	1.448 inch
*0627-045	45.223 ± .178 inch	1.448 inch
*0627-046	45.998 ± .178 inch	1.448 inch
*0627-047	43.547 ± .178 inch	1.448 inch
*0627-048	46.986 ± .178 inch	1.448 inch
*0627-049	48.162 ± .178 inch	1.448 inch
*0627-059	48.162 ± .178 inch	1.448 inch
**0627-060	45.998 ± .178 inch	1.448 inch
*0627-067	45.394 ± .178 inch	1.406 inch
*0627-069	42.953 ± .178 inch	1.406 inch
*0627-070	44.250 ± .178 inch	1.448 inch
***0627-073	43.547 ± .178 inch	1.448 inch
**0627-075	44.250 ± .178 inch	1.448 inch
**0627-076	43.547 ± .178 inch	1.448 inch
*0627-081	46.378 ± .178 inch	1.448 inch
***0627-082	46.259 ± .178 inch	1.448 inch
**0627-083	47.519 ± .178 inch	1.448 inch
***0627-084	47.519 ± .178 inch	1.448 inch
***0627-085	48.149 ± .178 inch	1.448 inch
***0627-086	48.149 ± .178 inch	1.448 inch

*High Performance **Improved Compression Resistance; Improved Heat Resistance ***Best Compression Resistance; Best Heat Resistance

■ **NOTE: The difference between a * drive belt and a ** drive belt of the same dimension is hardness. A ** drive belt is more flexible and if used in place of a * drive belt, the engine will run at a lower RPM.**

Index

#

120 ACCESSORIES 71

A

A-ARM KIT, 38" 42
ACCESSORY ADAPTER 66
AIRBOX KIT, SPLIT 68
ALTITUDE KITS, HIGH 80
ANTIFREEZE 63
AVALANCHE AIRBAG 38
AVALANCHE BEACON 38
AVALANCHE PROBE 38
AXLE KIT, LIGHTWEIGHT FRONT 43

B

BAGS

Backpacks 38-39
Dimensions 10
Foam Beverage Holder 18
Gear 14,36,44
Handlebar 16,36
Heater 16
Hydration 39
Mountain Pack 36
Rack Bag 15
Saddlebags 14
Seat Pack 14
Tank 15
Trunk, Firecat 17
Tunnel Pack 15,36,44
Underhood 17
Windshield 16,17,37
Replacement Hardware 18

BATTERIES 23

BATTERY CHARGERS/MAINTAINERS 66

BELTS, DRIVE

Application Guide 81
Dimension Chart 82
Holder 66

BILLET ACCESSORIES 27

BUMPER 19-20,46

C

CAM ROLLER, HI-TEMP 42

CARGO SLEDS 46

CAT WRAPS 27

CHOKE LEVER REPAIR KIT 70

CLEANERS 65

CLUTCH GUARD UPGRADE KIT 71

COVERS

Arctic Cat Canvas Covers 12
Custom 13
Dust 13
Half 13
Headlight 33
Premium 12
Team Arctic 12
Undercover Liner 13
Replacement Straps 13

D

DC Power Kit 22

DOLLY

Cat Caddy 59
Shop 59

DEEP SNOW KIT 68

E

ELECTRIC START KIT 22

ENGINE HEATER 23

F

FLUID

ACT Gearcase 63
Fox Float 64
Flush 63

FUEL

High Octane Race 65
De-Icer 63
Injection & Carburetor Cleaner 64
Stabilizer 64

FUEL CAN 43

FUEL PUMP REPAIR KITS 69

FUEL TANK 37

G

GASKET SETS 70

GAUGE, TEMPERATURE 67

GEAR SET, LOW RATIO 44

GOGGLE HOLDER 15, 37

GREASE 64

GRIP PLATES 34

H

HANDLEBAR

Grip Adhesive 69
Grips 29
Heavy-Duty 67
Mountain 41
Muffs 17
Risers 41, 67
Stand 59
Steering Post Stand 59

HAND GUARDS 28

HAND WARMER KIT 71

HAND WARMERS, PASSENGER 47

HEATED SEAT KIT 22

HEATED SHIELD ADAPTER 60

HELMET PARTS 72-78

HITCH KITS 21,47

HOOD LATCH REPAIR KIT 68

HOOD FLARES 33

I

ICE SCRATCHERS 40

L

LIFT

Sled 59

Front End 59

LIGHT

Backup 45

LOCTITE 69

LUBE

Gearcase 63

Chain 63

M

MIRRORS 34

N

NECK BRACE PARTS 79

O

OIL

Engine 62

Shock 63-64

OVERLOAD SPRING TOOL 70

P

PAINT 61

PROMOTIONAL PRODUCTS 83

R

RACK

Billet 38
Cargo 20,44
Sport 21
Crossfire 21
Procross 20
Proclimb 20,38
Touring 21
Mat/Pad 47
M Series 38
Strap 38

RADIATOR KIT 45

RAIL BRACE KIT 67

RECOIL HANDLE 27,35

REMOTE START KIT 22

S

SAW, POCKET 39

SEALANT 69-68

SEAT COVER, GRIPPER 34

SEAT KIT, 2-UP 19

SEAT KIT, PASSENGER 48

SEAT, MOUNTAIN 37

SEAT, THIRD 44

SHOCKS

FOX Float 26

Airshox Guards 26

Airshox Pump 26

Rebuild Kits 70

SHOVELS 40

SIDE RAILS 44

SKI

Plastic 29-30

Skins 47

SKID PLATES 32

SNOBUNJE 42

SNOWFLAPS 33-35,58

SNOW MESH 31

SNOW PLOW

Blades 47

Push Frame 47

SPARK PLUGS 69

Caddy 67

Caps 68

SPEEDOMETER/TACHOMETER 67

SPRING CHART, OPTIONAL 80-78

SPRING KIT, OVERLOAD 48

STAND, JACK 59

STEERING POST, TELESCOPIC 41

STEERING POST, VERTICAL 41

STEERING POST, HCR FIXED 42

STUD ACCESSORIES 53-58

SWAY BAR KITS 68

SWITCH GUARDS 41

T

TANK

Grips 36

Jacket 17

Pads 37

TAPE 60

TETHER SWITCH 23

THROTTLE BLOCK 68

TIE-DOWNS 60

TOE HOLD 35

TOW ROPE 60

TRACKS 49-50

TRACK CLIP TOOL 70

TRAIL GROOMER 46

TUNNEL FLARES 33

TUNNEL GRIPS 32

TUNNEL PROTECTOR KIT 58

TUNNEL RAILS 21

TUNNEL STRAP 18

TUNNEL UPGRADE KIT 71

V

VENTED SIDE PANELS 40

VENTED HOOD PANELS 40

W

WEARBARS 51-52

WEAR STRIPS 34

WHEEL, RAIL CAP 40

WHEELS, IDLER 35

WHEEL KITS 33,35,43,71

WINCH KIT, WARN 45

WIND DEFLECTORS 34

WINDSHIELDS/WINDSCREENS 24-25

WINDSHIELD HARDWARE 25

Snowmobile Safety and
3975 University Drive Suite 310



Certification Committee, Inc.
Fairfax, Virginia 22030 (703) 273-9606



Cobra™, HackSaw™, ICE Ripper™, and RipSaw™ are trademarks of Camoplast Inc. CTEK® is a trademark of CTEK Power, inc. EVOL™, FOX® and FOX FLOAT® AirShox™ are trademarks of FOX Racing Shox, Inc. Float Throttle™, and Tracker2™ are trademarks of Backcountry Access, Inc. NGK® is a trademark of NGK Spark Plugs, Ltd. OGIO® is a trademark of Ogio International. Deuce™, Power Plate™, Power Point™, Shaper™, StudBoy® and Super-Lite Plus™ are trademarks of Liberty Products, Inc. Powder Pro Skis™ is a trademark of Starting Line Products, Inc. Tekrider™ is a trademark of Tek Rider. Velcro® is a trademark of Scotchmate Inc. Warn® is a trademark of Warn Industries, Inc. Woody's®, Dooly™, Double Digger™, Gold Digger®, Grand Master™, Signature Series™, and Traction Master® are trademarks of International Engineering and Manufacturing, Inc. Yuasa® is a trademark of Yuasa Battery, Inc.

ACT™, Advantage®, Arctic Cat®, Arctic Power Valve™, Arcticwear®, A-Tex™, Bearcat®, Boss Cat™, Cat Comm™, Cat's Pride™, Cat's Pride Club™, Cat Tracker™, Cool Cat™, Cross Country™, Crossfire™, Firecat™, F Series™, Mountain Cat®, Panther®, Power Claw™, Pride™, Prowler®, Sabercat™, Share Our Passion™, Sno Cross®, Sno-Lock™, Sno Pro®, Speed Cat™, T660™, Team Arctic®, Tek™, Tom Cat™, World's Fastest Snowmobiles™, Z®, and ZR® are all trademarks of Arctic Cat Sales Inc., Thief River Falls, MN. ©2011 Arctic Cat Sales Inc.



Arctic Cat Sales Inc.
601 Brooks Avenue
Thief River Falls, MN 56701

All specifications, claims, and information contained within are based upon current knowledge as of August, 2013 and are subject to change without notice.

English - 5244-070